



Quangong Machinery Co., Ltd
Add: Taoyuan Industrial Zone, Fengzhou,
Quanzhou City, Fujian Province, China
Tel: +86-595-867 99299
Fax: +86-595-867 99577
Email: overseas@qzmachine.com

www.qzmachine.com



QUAN GONG MACHINERY

To Customize a Satisfied Mould for You



Visit us at website



WeChat

Quangong Machinery Co., Ltd
Germany/China/Austria

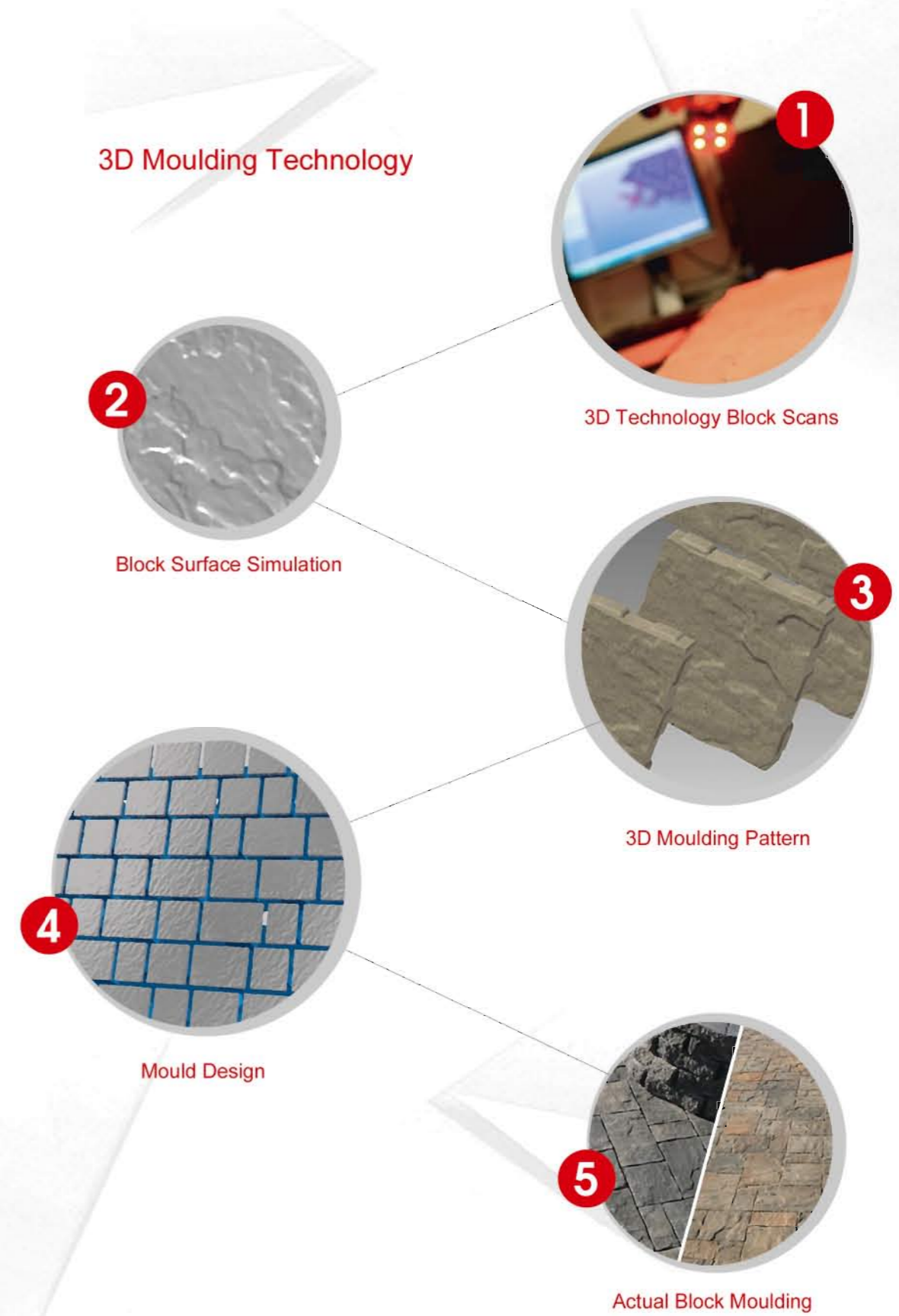

Company Profile

Founded in 1979, QGM is the leading block machine manufacturer and has the longest history of block making machine manufacturing in China.

Start from 2012, QGM has set up offices around the world, including Saudi Arabia, Oman, Algeria, Indonesia, India, Nigeria, Vietnam, Zambia, South Africa and Dubai. With the growing sales, more new overseas offices will be set up to better serve our clients all over the world.

In 2013, with the appliance of the most advanced frequency conversion technology from QGM R&D Center, new model ZN1000C and ZN1500C were launched. ZN series block machine are well known for its high production capacity and stable performance.

In 2014, QGM fully acquired Zenith Maschinenfabrik GmbH. Benefiting from the close collaboration between Germany Zenith technology and QGM China Manufacturing center, QGM Group is able to provide a wide range products to global users, from simple automatic production line to fully automatic production line, from stationary automatic production line to mobile automatic production line.

In 2016, QGM fully acquired Zenith Formen Produktions GmbH in Frestriz, Austria.

In 2017, QGM Group and Sommer Anlagentechnik GmbH reached a strategic partnership on world-wide leading automatic and intelligent pre-cast production technology.

Benefiting from the close collaboration of Zenith Maschinenfabrik GmbH, Zenith Formen Produktions GmbH, Germany Sommer pre-cast technology and QGM China manufacturing center, QGM group is an internationally well-known manufacturer of high-end system and machines for concrete industry, turning into a wider range product supplier.



Our Equipment

QGM firmly believes that good quality starts with precision and ends with perfection. Designs and technologies from Germany and Austria also require advanced manufacturing processes. QGM has mastered sophisticated monitoring instruments and has advanced management capabilities. Its production and processing capabilities have been at the forefront of the industry for many years, from the advanced technology of Germany and Austria and the advanced manufacturing level of QGM, combined with materials, process, quality and precision from QGM mould that leading the domestic world.



CNC Processing Workshop



CNC Processing



Wire Cutting Workshop



Wire Cutting



CNC Planomiller Workshop



CNC Planomiller Processing



Milling Machine Processing



Circle Grinding Processing



Laser Cutting



Planomiller Processing



Heat Treatment



Boring Milling Processing



Lock Screw



Template Matching



Paver

TO CUSTOMIZE A SATISFIED
MOULD FOR YOU

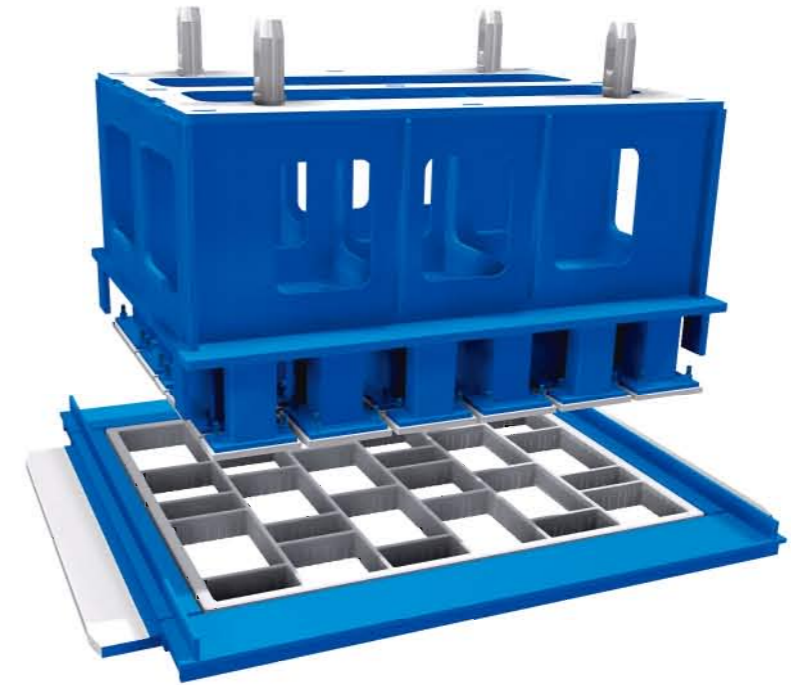

Paver

QGM paver mould adopts low carbon alloy high strength carburizing steel and integrates precise wiring cutting technology, high-precision CNC processing technology and 3D scanning technology to provide customers with mould customization. These technologies can design a variety of contours and geometric shapes. Its clearance of 0.3-0.4mm, with precise vertical corners and smooth sidewalls. Pavers produced by QGM are easy-demoulding, high precision, no burrs around. Moulds can realize digital free surface design and pressure plates interchange design.

In order to ensure the durability of the mould, QGM paver mould adopts carburizing treatment, mould frames and pressure plates are hardened 60-63HRC, and the minimum hardening depth is 1.2mm. According to customers' requests, the mould can be designed and manufactured by welding or modular thread locking.

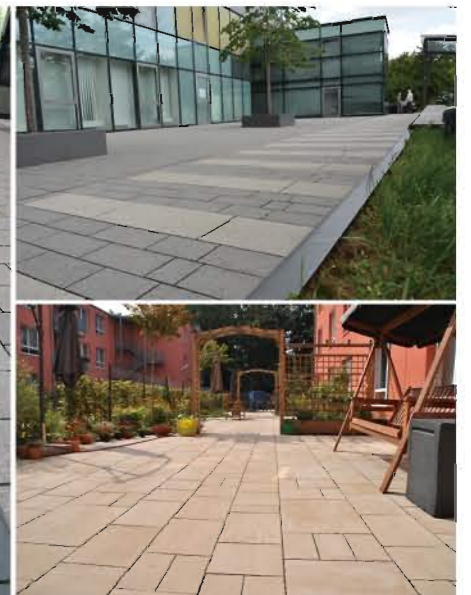
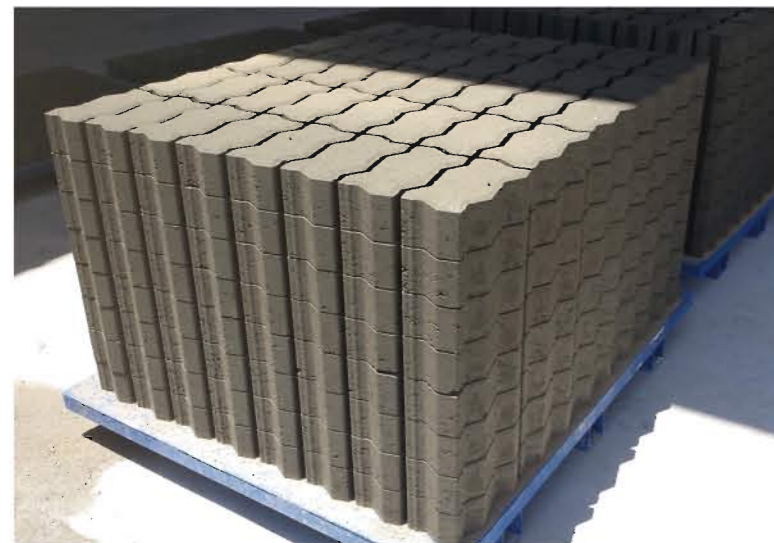

LM 0001

LM 0001-1

No.	Dimension(L x W)	Area(dm ²)	Pcs/m ²
LM 0001	200X100	2	50
LM 0001-1	100X100	1	100

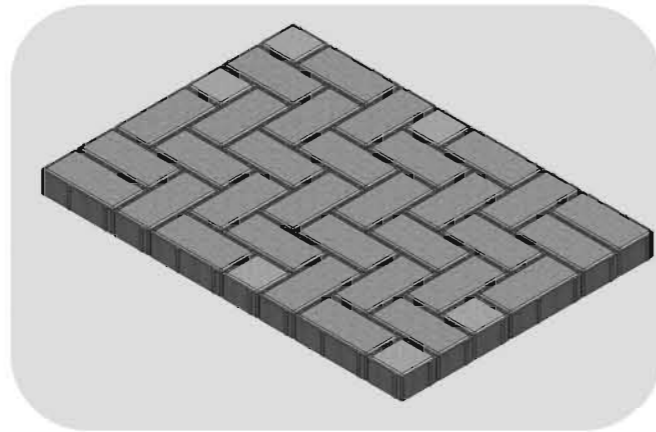
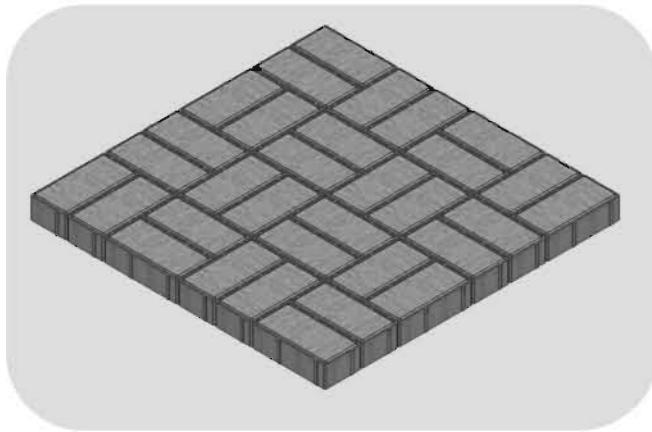
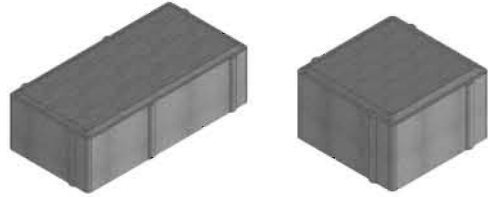

LM 0002

LM 0002-1

No.	Dimension(L x W)	Area(dm ²)	Pcs/m ²
LM 0002	225X112.5	1.27	39.5
LM 0002-1	112.5X112.5	2.53	79

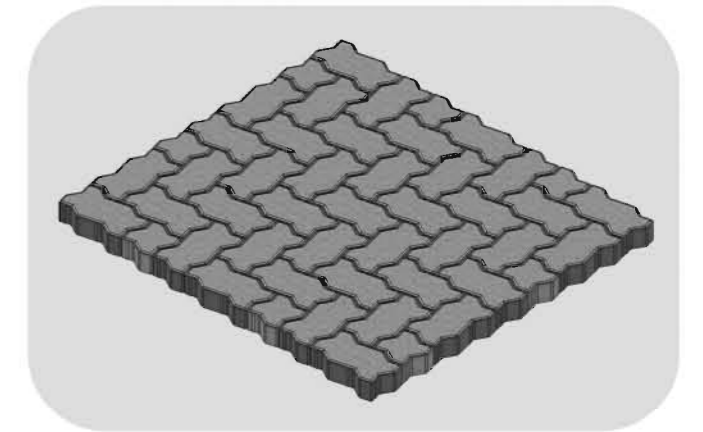
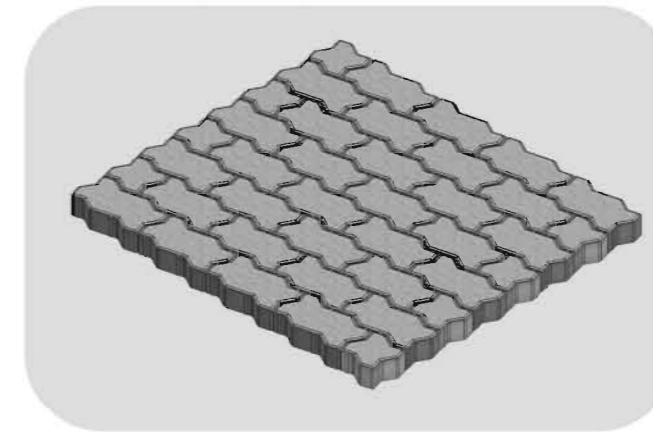
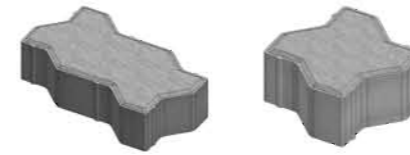

LM 0001-2

LM 0001-3

No.	Dimension(L x W)	Area(dm ²)	Pcs/m ²
LM 0001-2	200X100	2	50
LM 0001-3	200X100	2	50

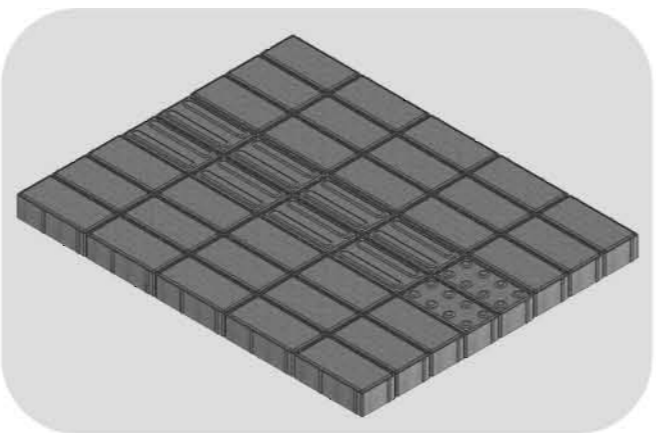
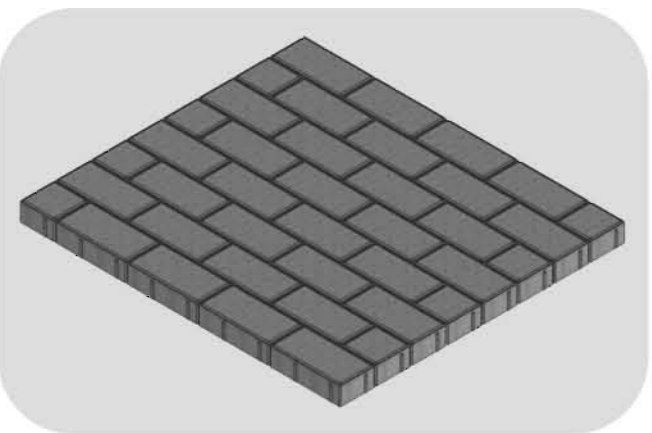
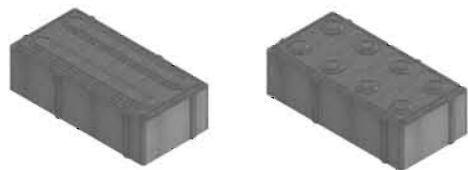

LM 0003

LM 0003-1

No.	Dimension(L x W)	Area(dm ²)	Pcs/m ²
LM 0003	230X115	2.64	37.8
LM 0003-1	115X115	1.32	75.7

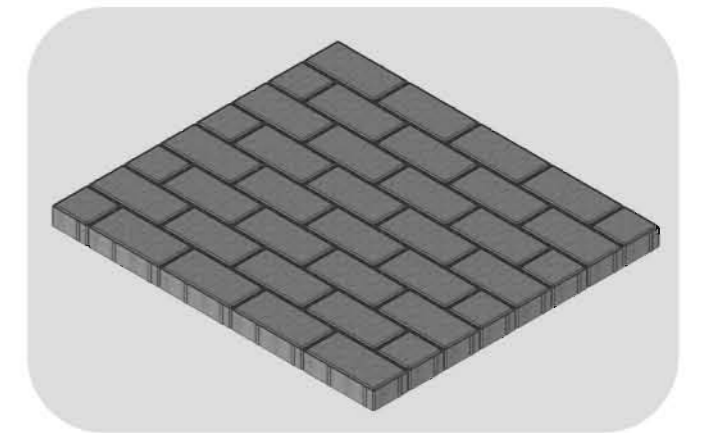
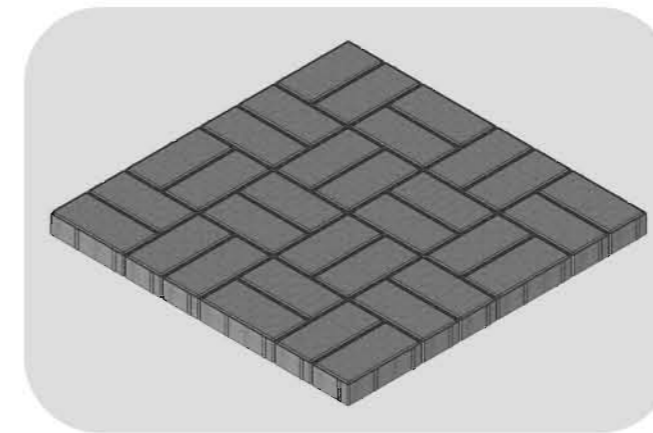
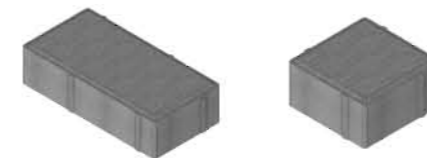

LM 0004

LM 0004-1

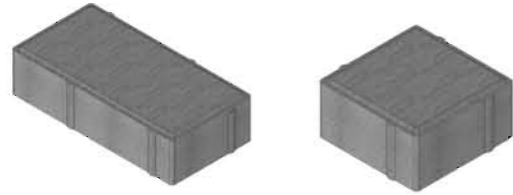

No.	Dimension(L x W)	Area(dm ²)	Pcs/m ²
LM 0004	240X120	2.88	34.7
LM 0004-1	120X120	1.44	69.4

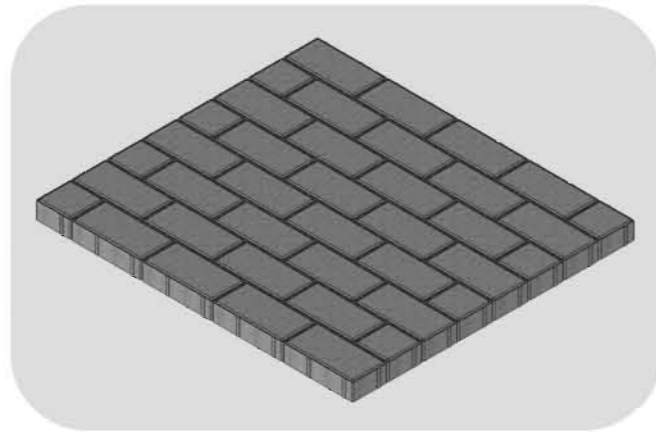
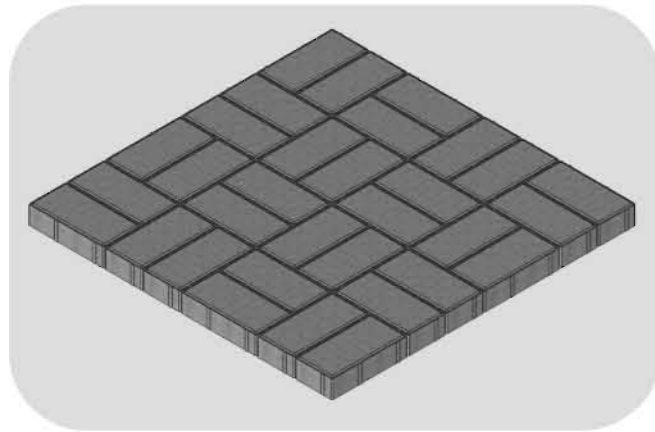

LM 0007

LM 0007-1

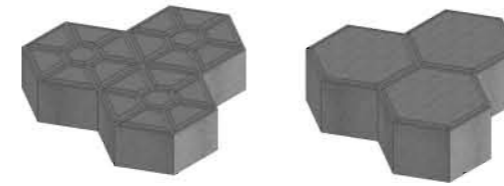

No.	Dimension(L x W)	Area(dm ²)	Pcs/m ²
LM 0007	250X250	4.06	24.6
LM 0007-1	250X250	4.06	24.6

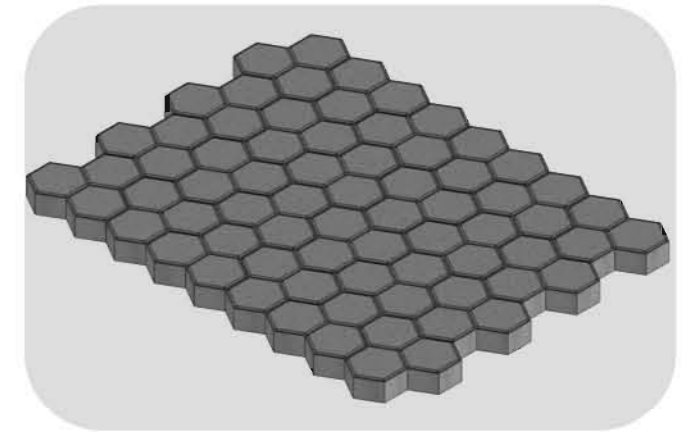
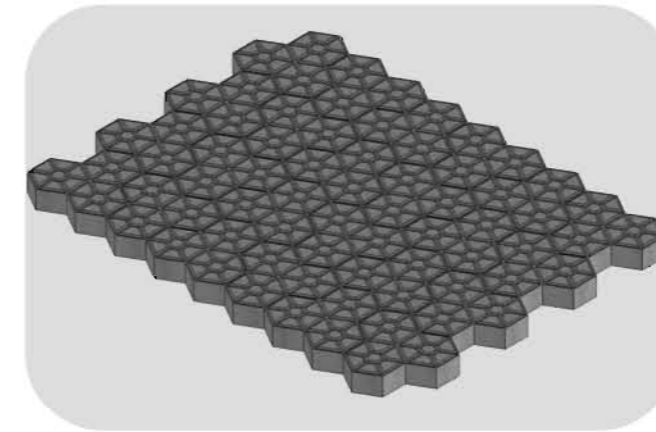

LM 0005

LM 0006

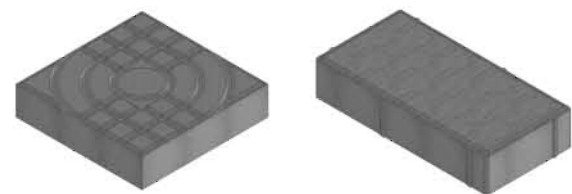

No.	Dimension(L x W)	Area(dm ²)	Pcs/m ²
LM 0005	250X250	6.25	16
LM 0006	300X150	4.5	22.2

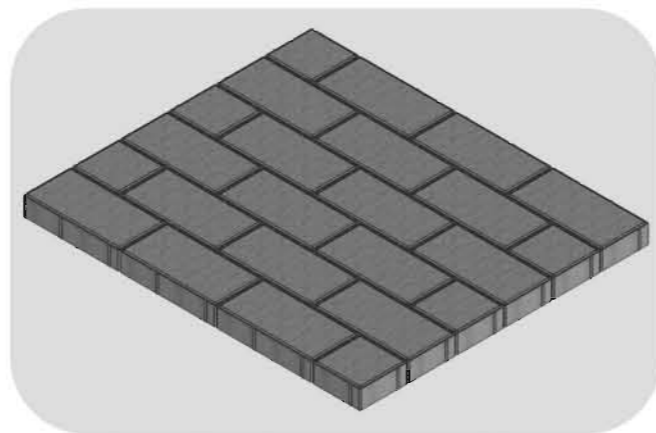
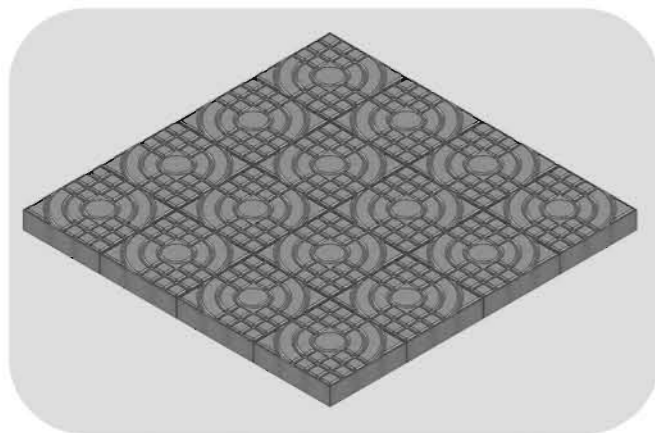

LM 0008

LM 0009

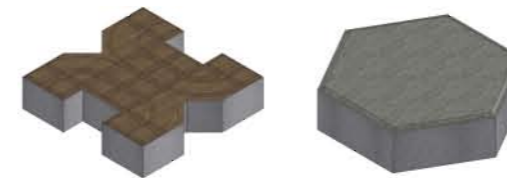

No.	Dimension(L x W)	Area(dm ²)	Pcs/m ²
LM 0008	250X250	6.25	16
LM 0009	250X250	4.06	24.6

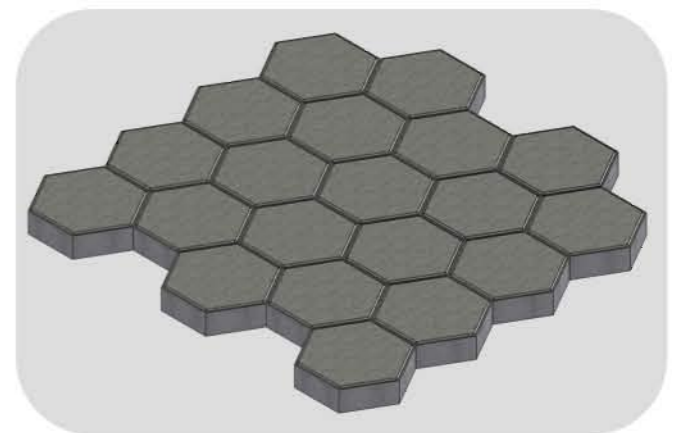
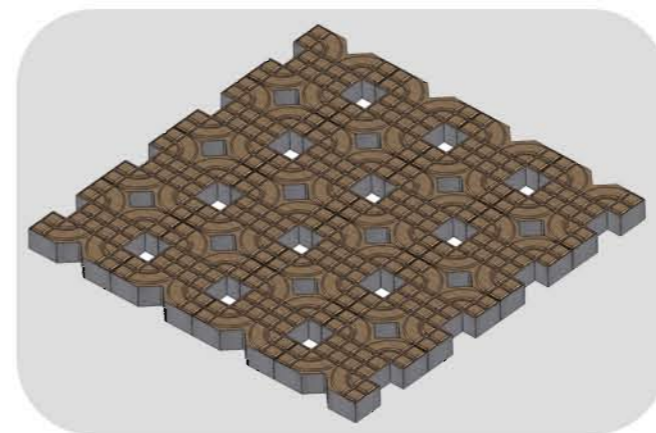

LM 0010

LM 0010-1



No.	Dimension(L x W)	Area(dm ²)	Pcs/m ²
LM 0010	210X110	2.42	41.3
LM 0011-1	110X110	1.21	82.6

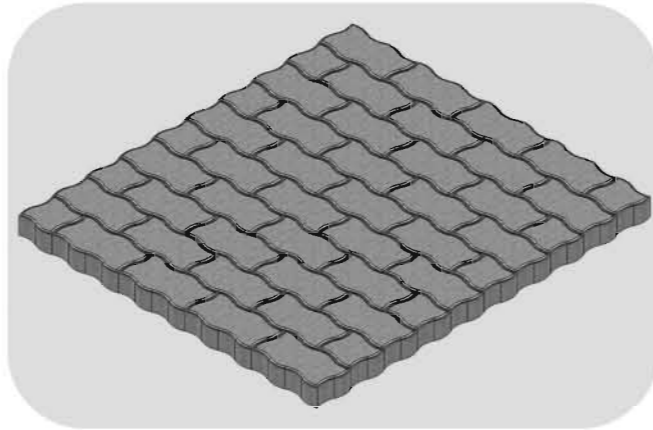
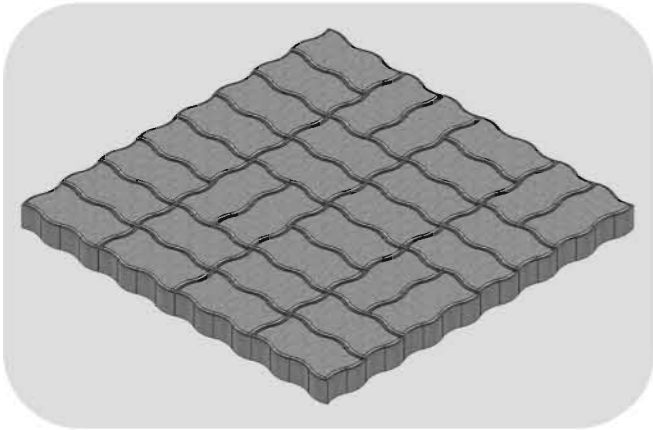

LM 0011

LM 0011-1

LM 0011-2



No.	Dimension(L x W)	Area(dm ²)	Pcs/m ²
LM 0011	200X200	4	25
LM 0011-1	200X200	4	25
LM 0011-2	200X200	4	25

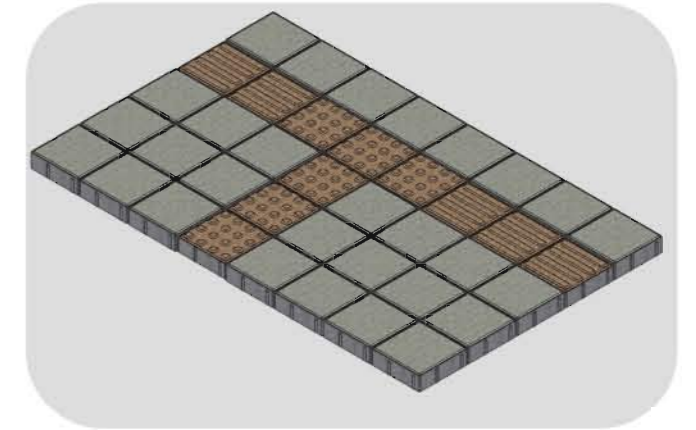
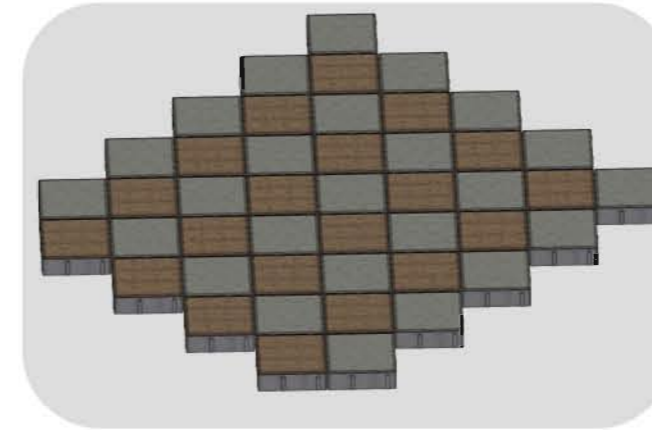

LM 0012

LM 0012-1

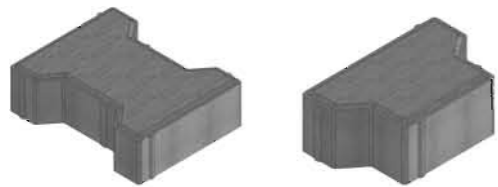

No.	Dimension(L x W)	Area(dm ²)	Pcs/m ²
LM 0012	200X160	2.7	37
LM 0012-1	100X160	1.35	74

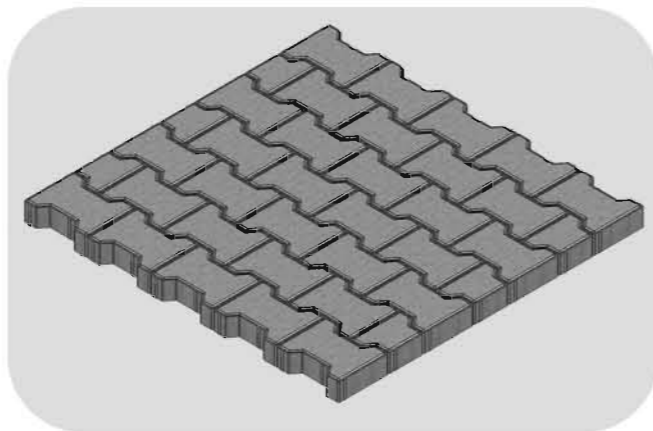
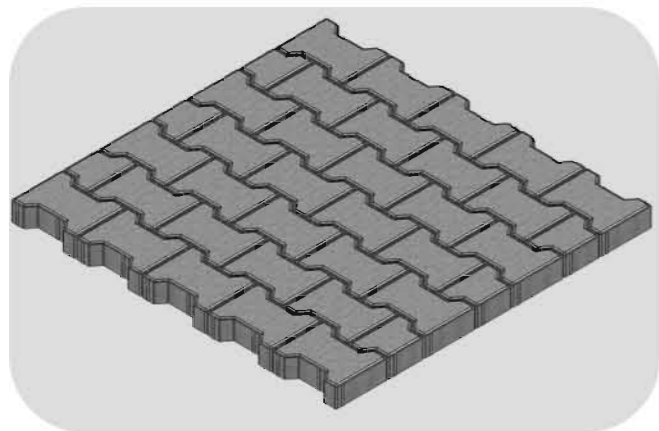

LM 0013

LM 0014

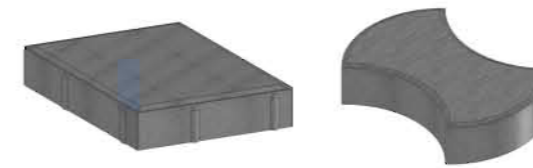

No.	Dimension(L x W)	Area(dm ²)	Pcs/m ²
LM 0013	342.4X197.7	3.4	29.4
LM 0014	272X190	3.61	27.7

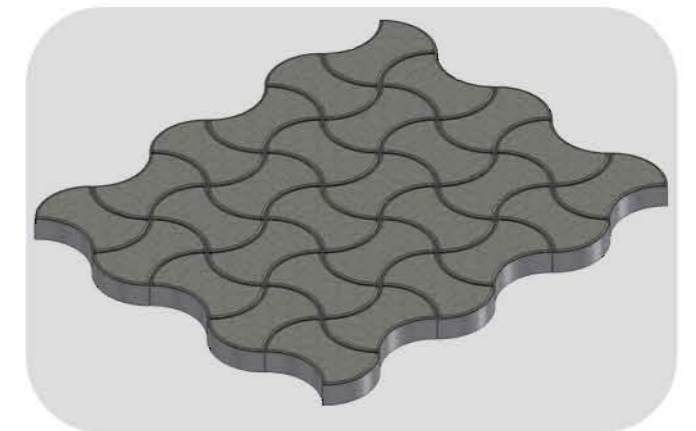
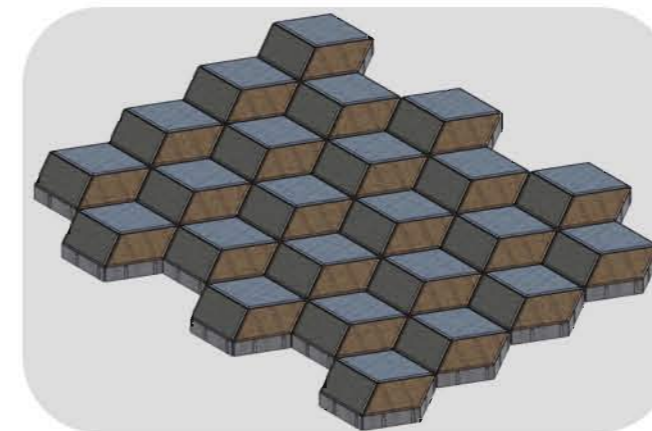

LM 0015

LM 0016

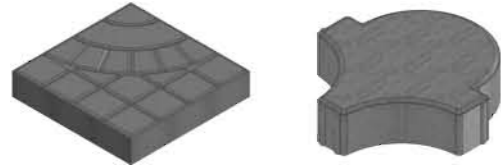

No.	Dimension(L x W)	Area(dm ²)	Pcs/m ²
LM 0015	300X300	9	11.1
LM 0016	200X195	2.32	43

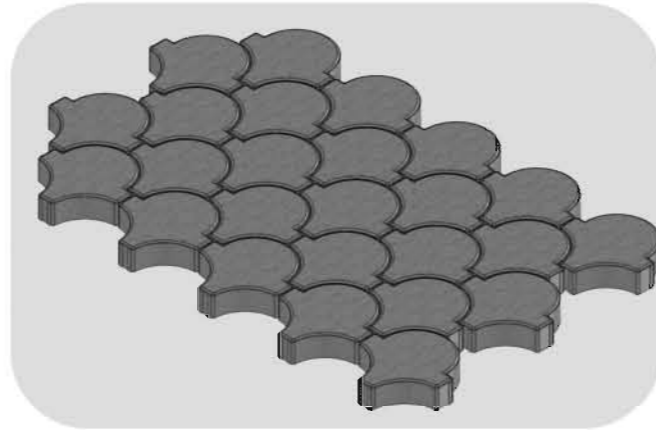
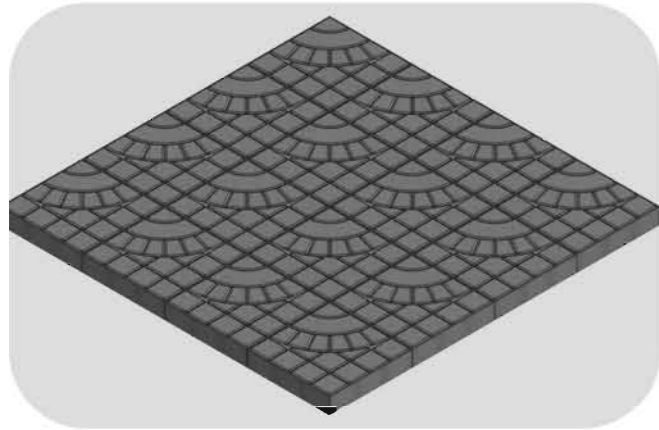

LM 0019

LM 0020

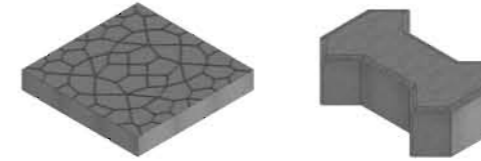

No.	Dimension(L x W)	Area(dm ²)	Pcs/m ²
LM 0019	400X400	16	6.25
LM 0020	197X135	1.83	54.6

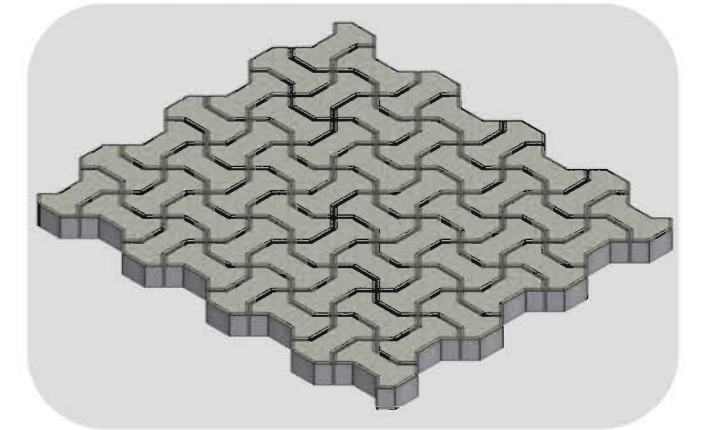
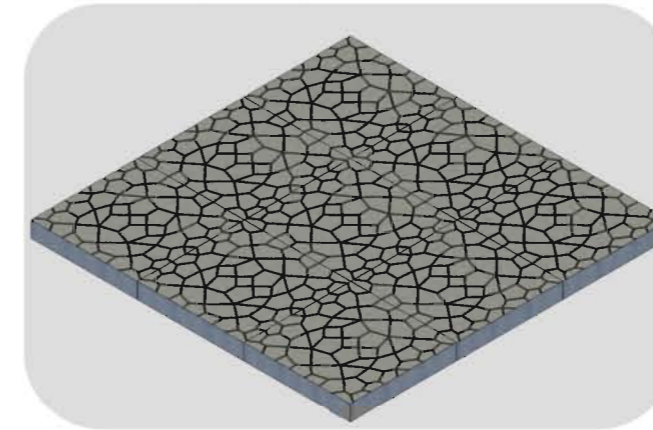

LM 0017

LM 0018

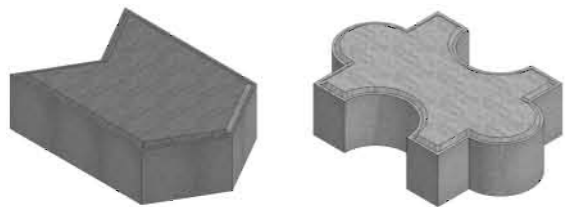

No.	Dimension(L x W)	Area(dm ²)	Pcs/m ²
LM 0017	160X140	2.24	44.6
LM 0018	240X160	2.56	39

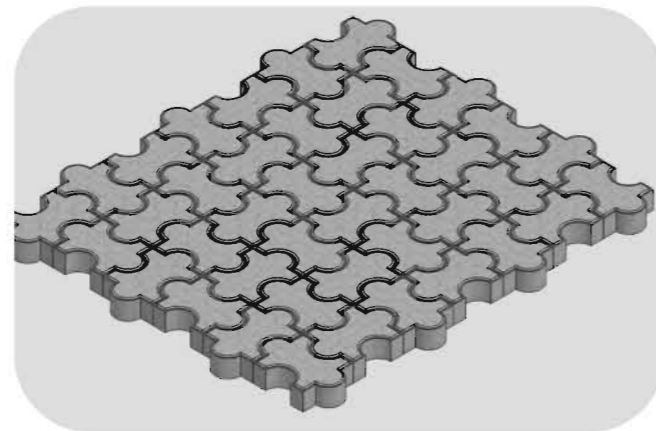
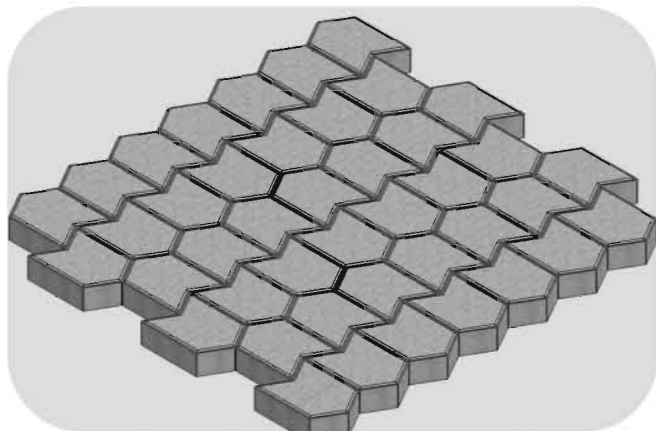

LM 0021

LM 0022

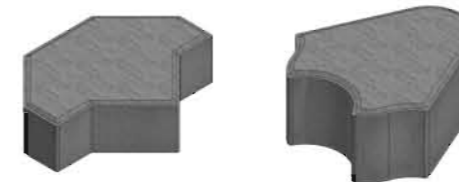

No.	Dimension(L x W)	Area(dm ²)	Pcs/m ²
LM 0021	226X176	2.54	39.4
LM 0022	191.4X177.9	1.95	51.3

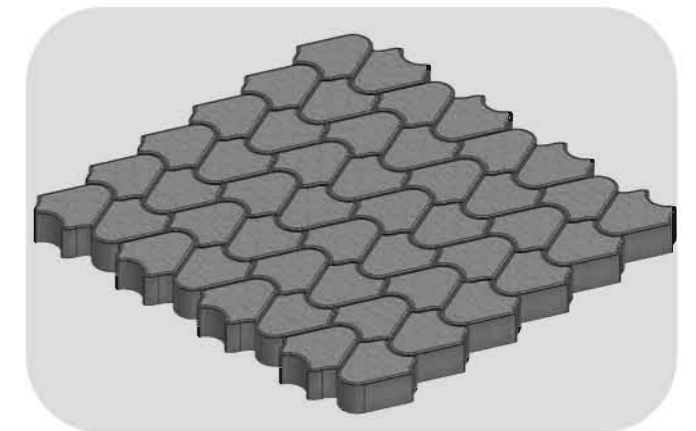
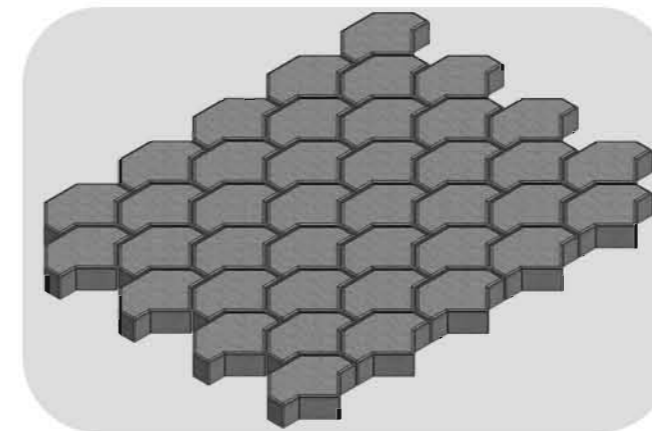

LM 0023

LM 0024

No.	Dimension(L x W)	Area(dm ²)	Pcs/m ²
LM 0023	200X200	2.6	38.4
LM 0024	191X146	2.78	36

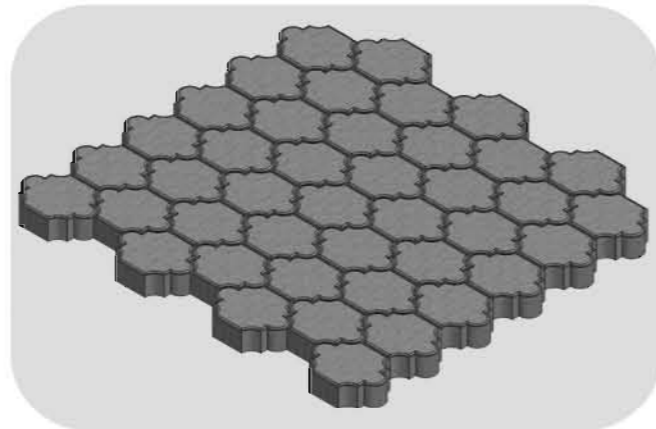
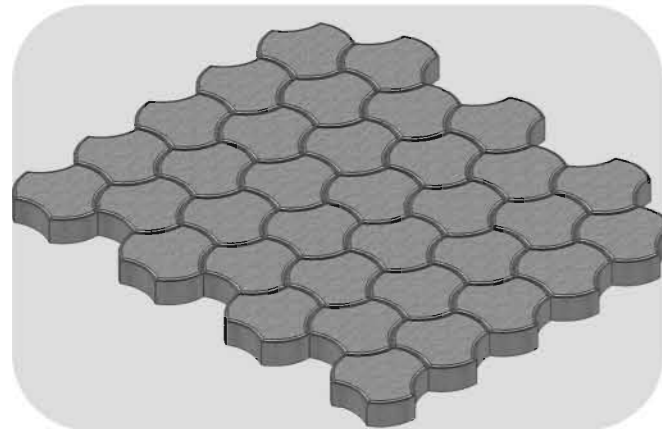

LM 0027

LM 0028

No.	Dimension(L x W)	Area(dm ²)	Pcs/m ²
LM 0027	245X220	4.78	20.9
LM 0028	204X204	2.71	36.9

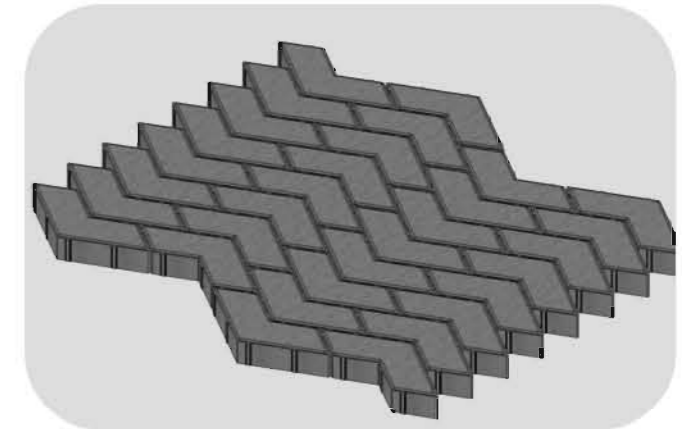
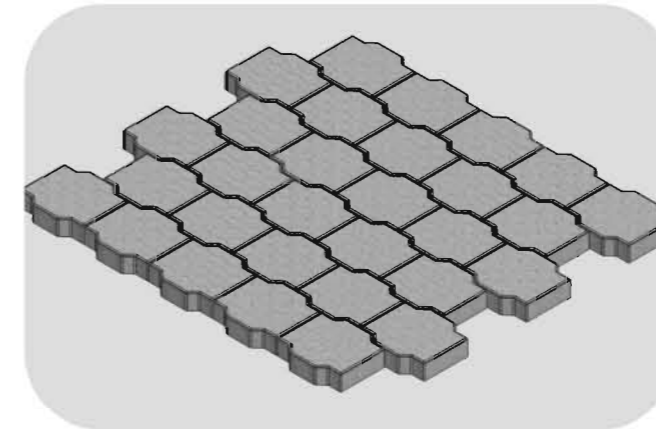
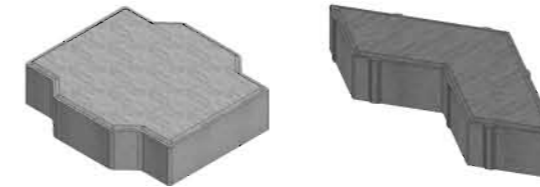

LM 0025

LM 0026

No.	Dimension(L x W)	Area(dm ²)	Pcs/m ²
LM 0025	275X256.3	4.06	24.6
LM 0026	240X160	3.07	32.5

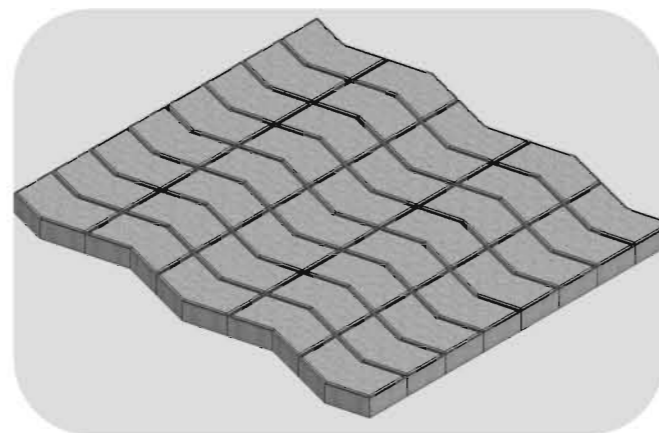
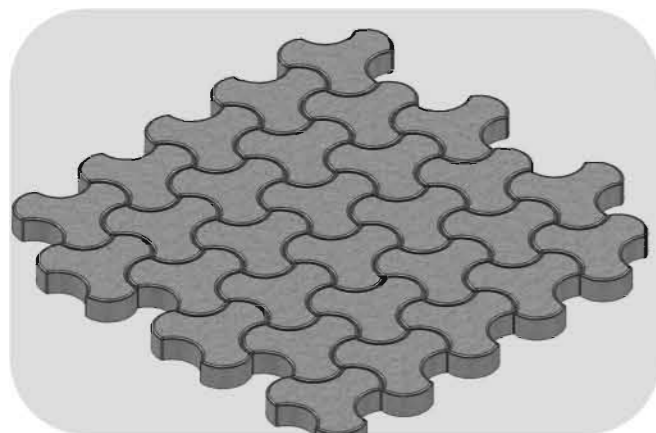
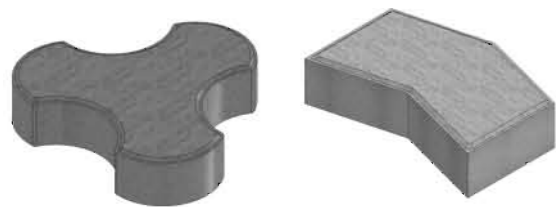

LM 0029

LM 0030

No.	Dimension(L x W)	Area(dm ²)	Pcs/m ²
LM 0029	227X137	2.25	39.2
LM 0030	199X185.6	2.57	38.9

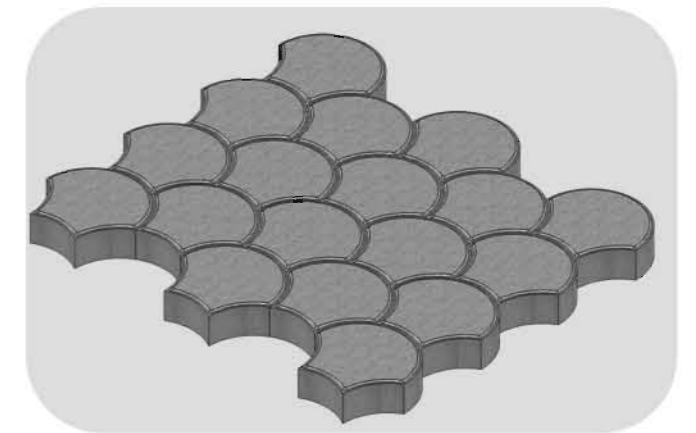
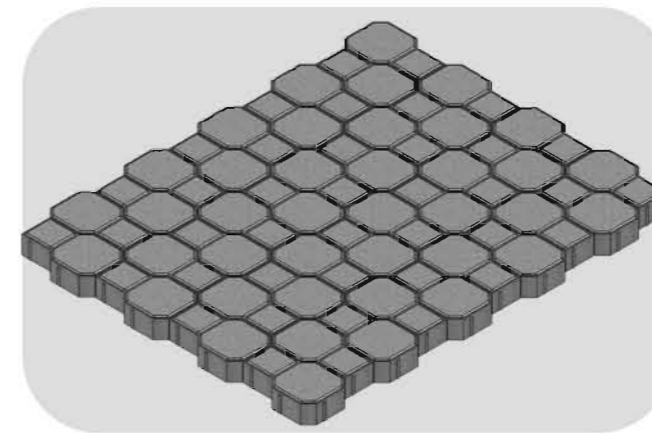
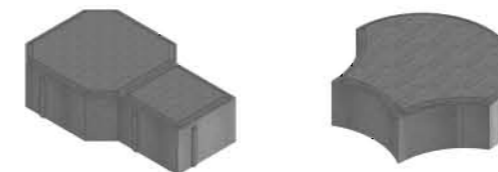

LM 0031

LM 0032



No.	Dimension(L x W)	Area(dm ²)	Pcs/m ²
LM 0031	225X129.9	1.95	51.2
LM 0032	226.3X226.3	2.56	39

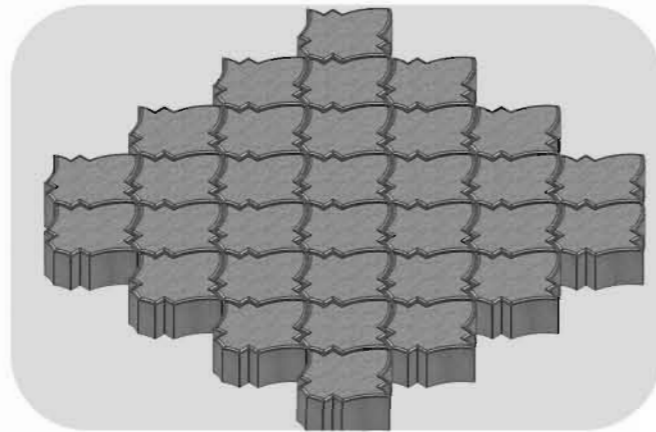
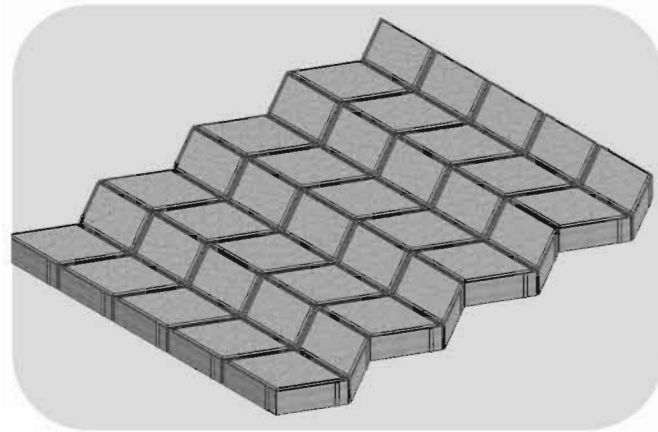

LM 0035

LM 0036

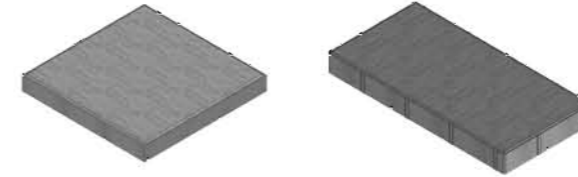

No.	Dimension(L x W)	Area(dm ²)	Pcs/m ²
LM 0035	500X500	25	4
LM 0036	600X300	18	5.5

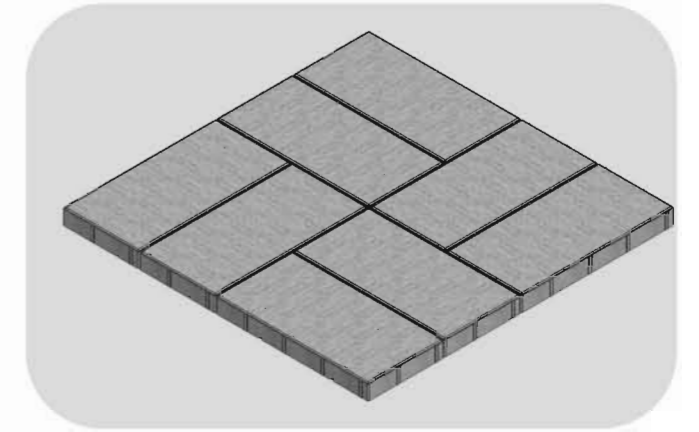
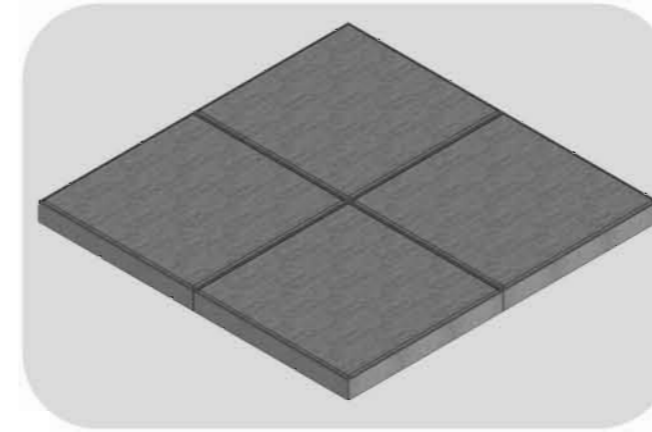

LM 0033

LM 0034



No.	Dimension(L x W)	Area(dm ²)	Pcs/m ²
LM 0033	500X250	12.5	8
LM 0034	1000X500	0.5	2

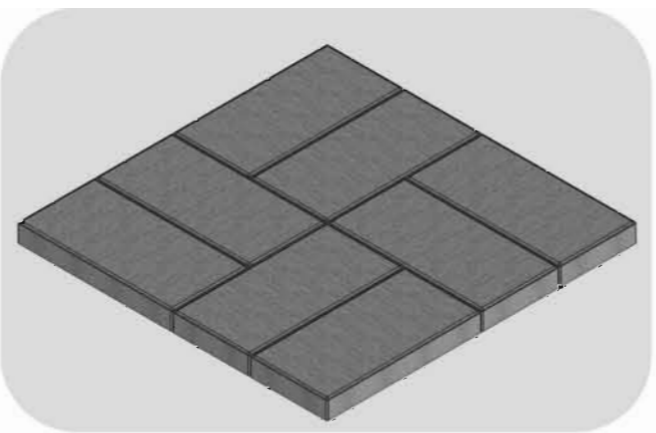
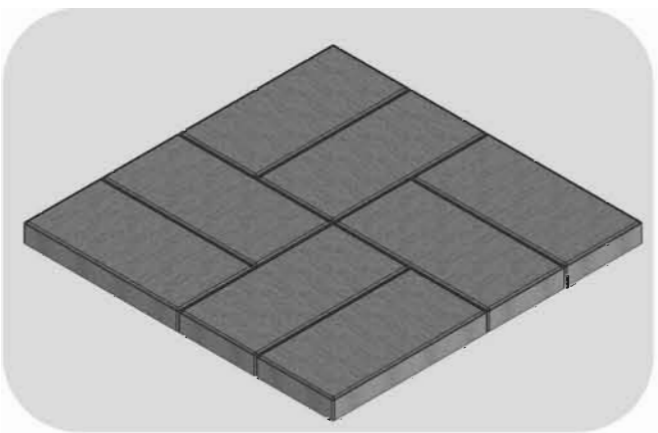

LM 0037-1

LM 0037-2



LM 0037-3

LM 0037-4



LM 0037-5



No.	Dimension(L x W)	Area(dm ²)	Pcs/m ²
LM 0037-1	180X120	2.16	46.3
LM 0037-2	120X120	1.44	69.4
LM 0037-3	120X90	1.08	92.6
LM 0037-4	120X71	1.1	90.9
LM 0037-5	120X50	1.1	90.9

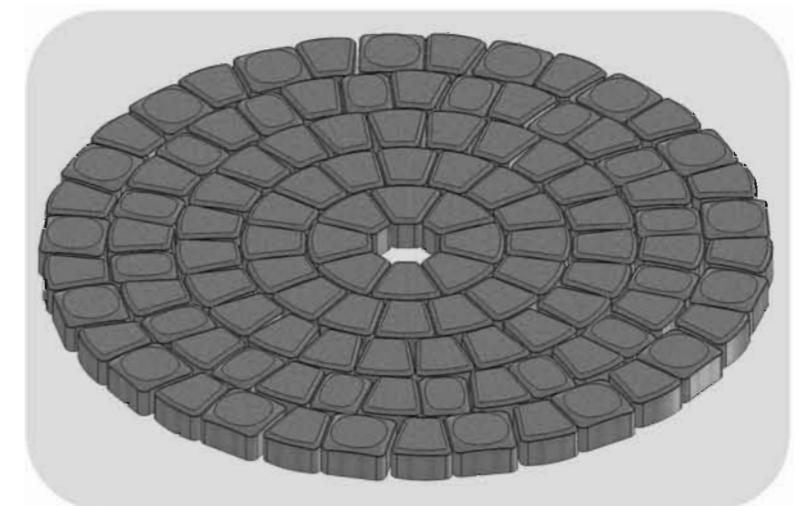

以上尺寸和形状，可根据实际情况进行调整。



Hollow Block



Hollow Block

Hollow block moulds are made of high quality wear-resistant steel. Through the wire cutting process, the gap between the upper and lower sides of the mould is reasonable, clearance 0.8-1mm, which make the mould strong and durable. The integrated heat treatment process makes the moulds more wear-resistant and durable. According to the requirements of different customers, it can provide a variety of specifications and designs. The mould adopts flexible design, according to customer needs, the mould core, pressure plate can be freely replaced, also we provide welding, modular thread locking design and manufacture.

Curbstone Series
 In order to better serve our customers, we have long-term explorations in the field of curbstone mould design and have accumulated rich experience. We can meet the different needs of customers and provide moulds with various requirements such as slopes, facades, with facemix, and without facemix.



KX 1001



No.	Dimension(L x W)
KX 1001	
KX 1001-1	390X190X190
KX 1001-2	400X200X200
KX 1001-3	

KX 1003

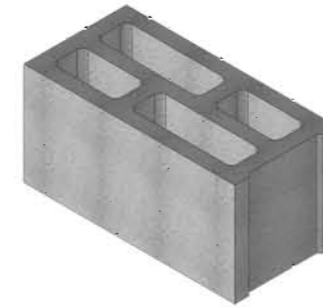

No.	Dimension(L x W)
KX 1003	
KX 1003-1	390X190X190
KX 1003-2	400X200X200
KX 1003-3	

KX 1001-1

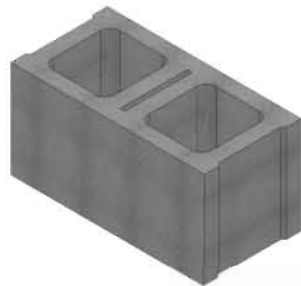

KX 1001-2

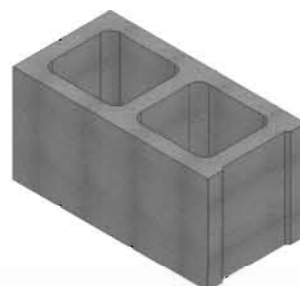

KX 1001-3

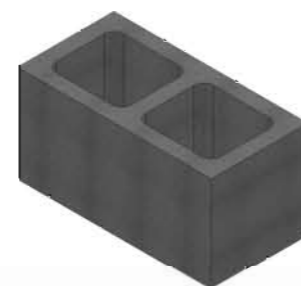

KX 1003-1



KX 1003-2



KX 1003-3



KX 1002



No.	Dimension(L x W)
KX 1002	
KX 1002-1	390X190X190
KX 1002-2	400X200X200
KX 1002-3	

KX 1004



No.	Dimension(L x W)
KX 1004	
KX 1004-1	390X190X190
KX 1004-2	400X200X200
KX 1005	240X115X90

KX 1002-1



KX 1002-2

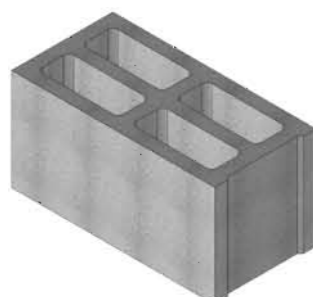

KX 1002-3



KX 1004-1



KX 1004-2

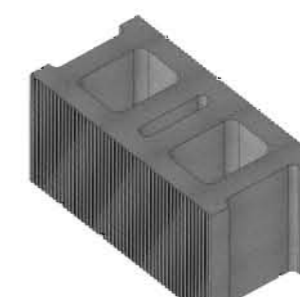

KX 1005



KX 1006

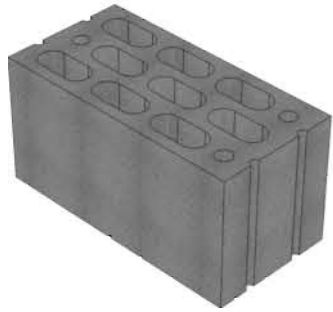

No.	Dimension(L x W)
KX 1006	400X200X200
KX 1007	390X140X190
KX 1008	370X140X200
KX 1009	390X190X190

KX 1013-1

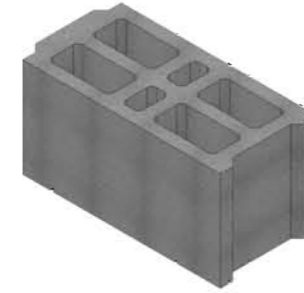

No.	Dimension(L x W)
KX 1013-1	400X200X200
KX 1014	400X200X200

KX 1007

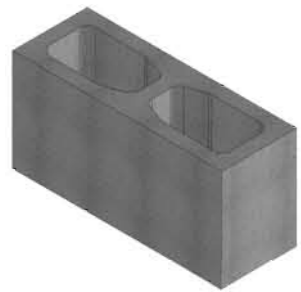

KX 1008



KX 1009



KX 1014

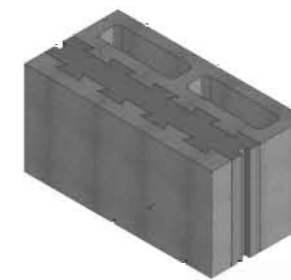

Semi-Blind Hole

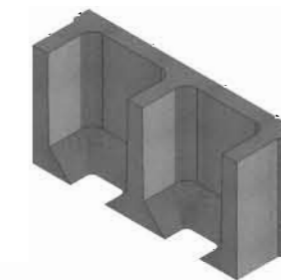

Blind Hole

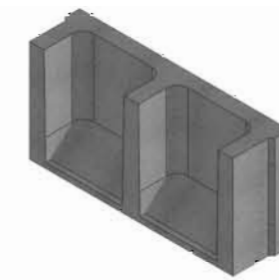

Through Hole



KX 1010



No.	Dimension(L x W)
KX 1010	500X200X250
KX 1011	520X150X200
KX 1012	500X90X250
KX 1013	400X200X200

KX 1011



KX 1012

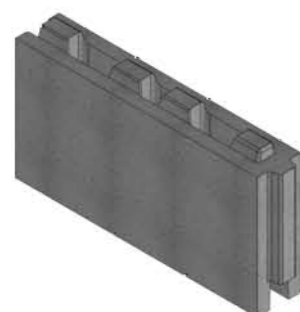

KX 1013



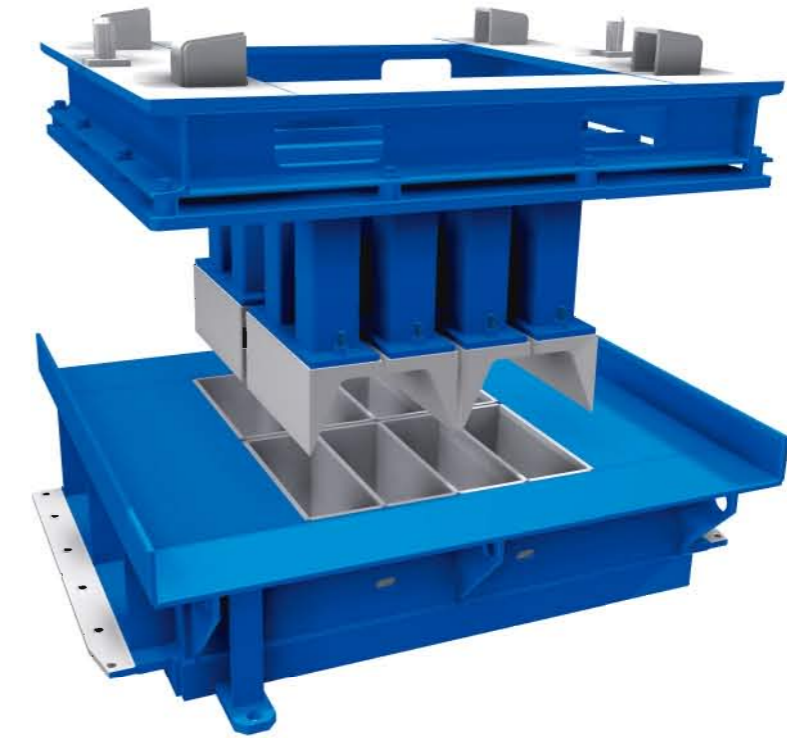

Curbstone

Curbstone

QGM curbstone mould adopts imported high quality wear-resistant steel, combined with great welding and processing technology, the plate adopts a special heat treatment process to ensure the wear resistance of the plate, clearance 0.5-0.6mm, the supporting web is a replaceable threaded connection design.

The mould frame has hydraulic device, the frame plate can be folded as needed, the wearing parts can be easily replaced. According to the customer's requirement, bevels, facades of mould and mould with or without facemix are available, we can also provide the mould with replaceable press plate to achieve the change of the curbstone's height and bevel.



LY 3001



No.	Dimension(L x W)
LY 3001	800X250X120
LY 3001-1	580X300X150 (Outer Diameter Φ 1000)
LY 3001-2	1000X300X150
LY 3001-3	1000X300X150
LY 3001-4	1000X300X150

LY 3001-1

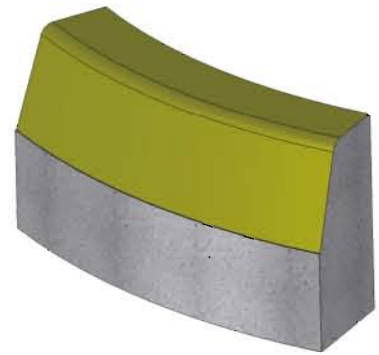

LY 3001-2

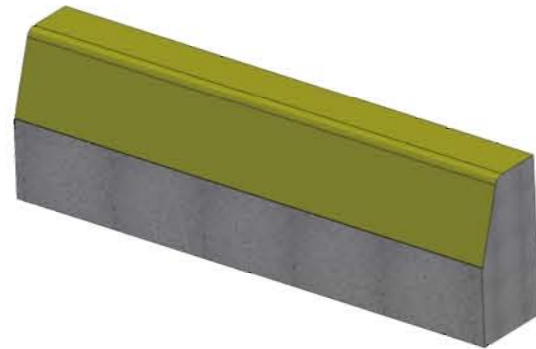

LY 3001-3

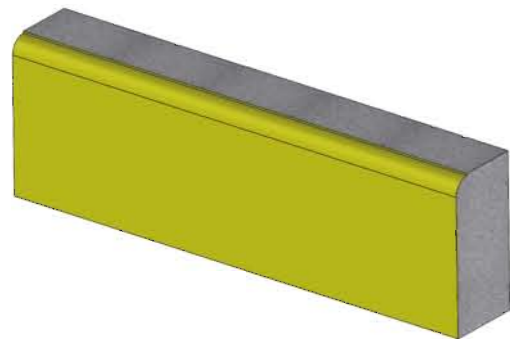

LY 3001-4

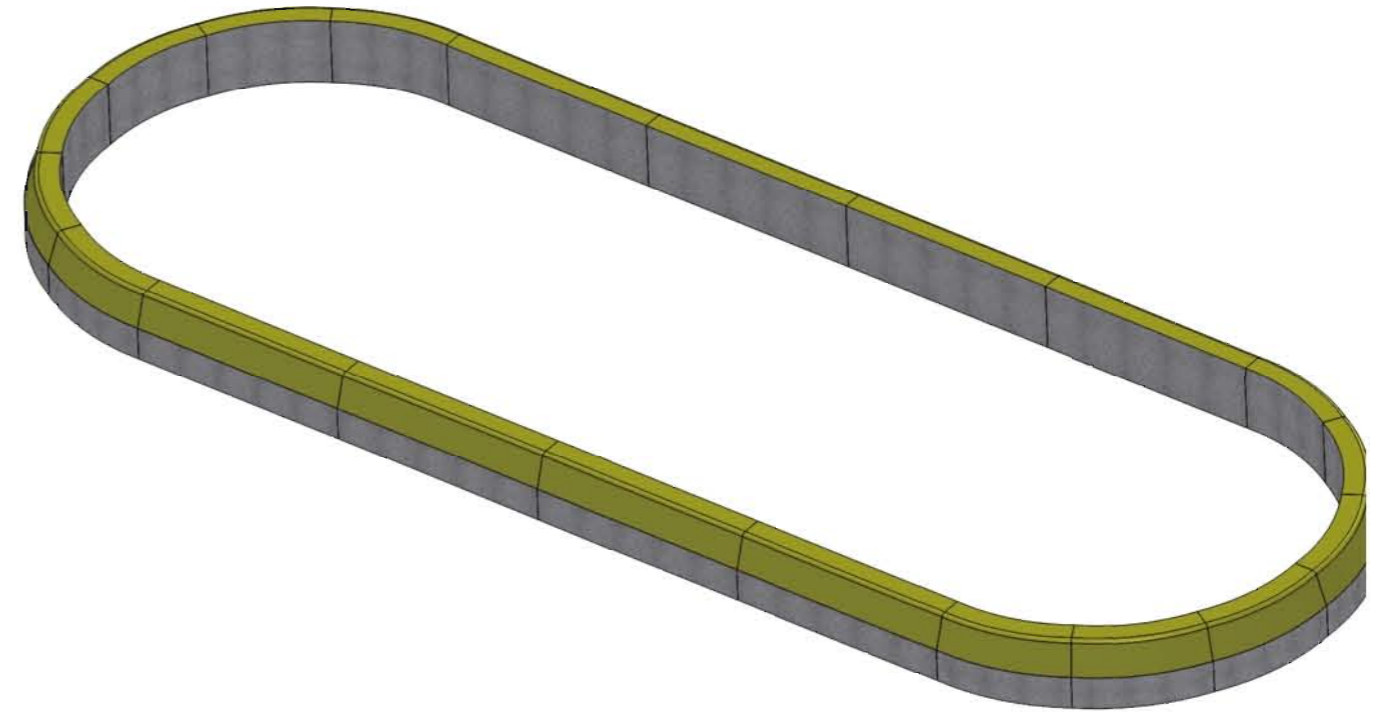
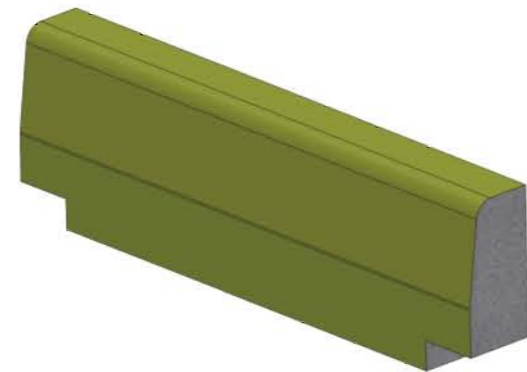



Grass Paver



Grass Paver

QGM grass paver mould adopts low carbon alloy high strength carburizing steel, clearance 0.5-0.6mm, the suspension plate adopts imported wear-resistant high-strength structural steel, which is durable and not easy to wear. The core is wire-cutting with precise vertical corners and smooth sidewalls for aesthetics and practicality.

A variety of shapes and contours can be designed according to customer's requirements, and the pressure plate and mould spare parts can be replaced at any time. Customize the shape with 3D scanning technology.



ZC4001

ZC4002

No.	Dimension(L x W)	Area(dm ²)	Pcs/m ²
ZC4001	400X400	16	6.2
ZC4002	400X200	8	12.5

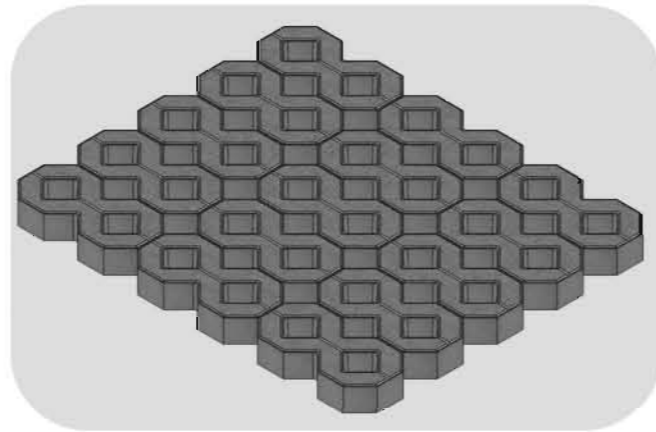
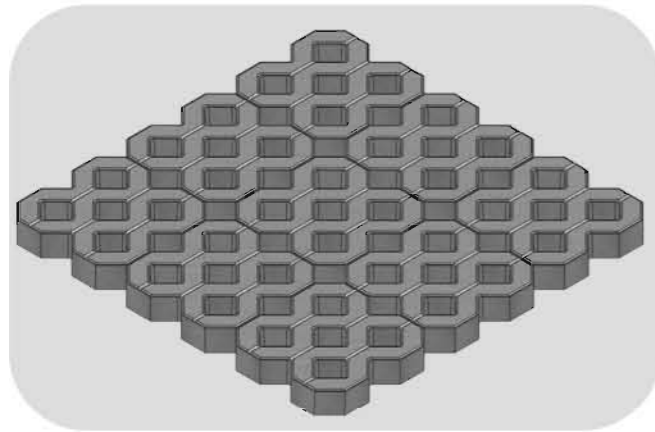
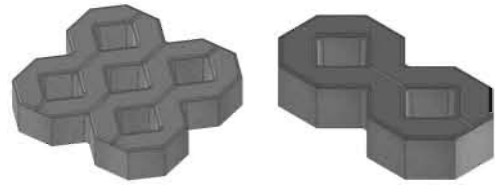

ZC4005

ZC4006

No.	Dimension(L x W)	Area(dm ²)	Pcs/m ²
ZC4005	250X250	6.25	16
ZC4006	300X300	9	11

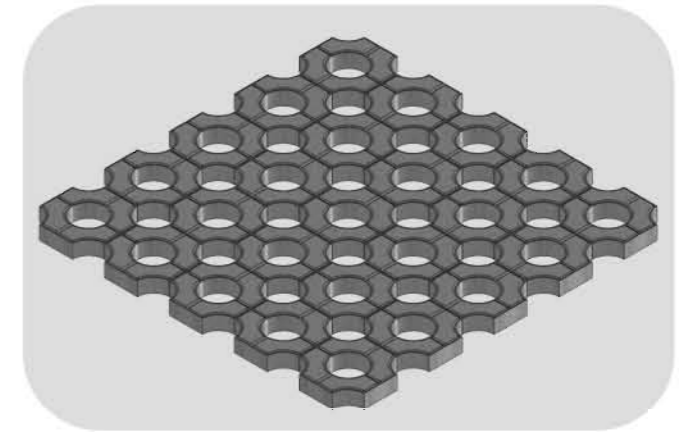
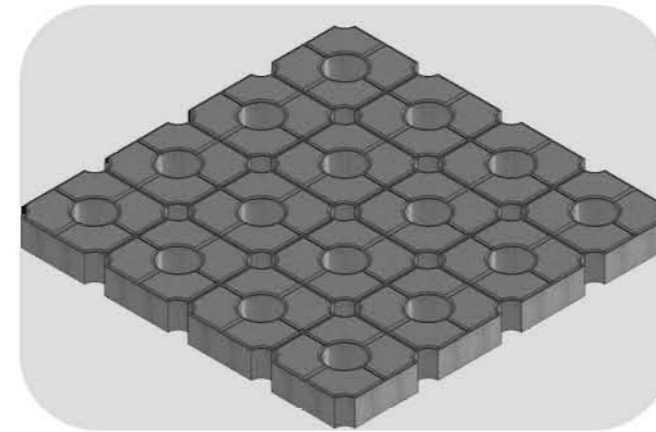
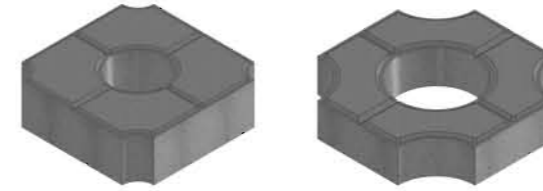

ZC4003

ZC4004

No.	Dimension(L x W)	Area(dm ²)	Pcs/m ²
ZC4003	245X185	4.53	22
ZC4004	400X400	16	6.2

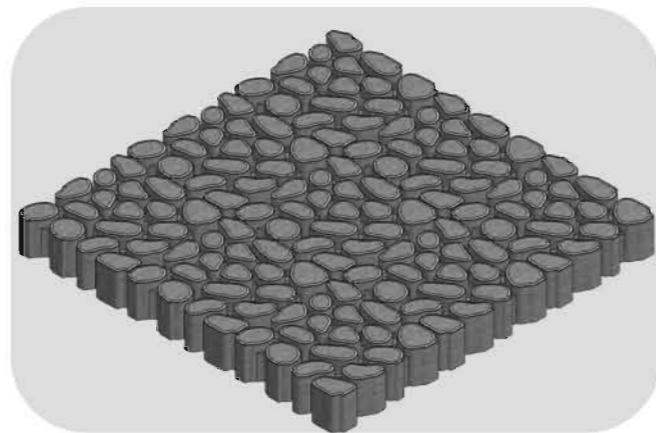
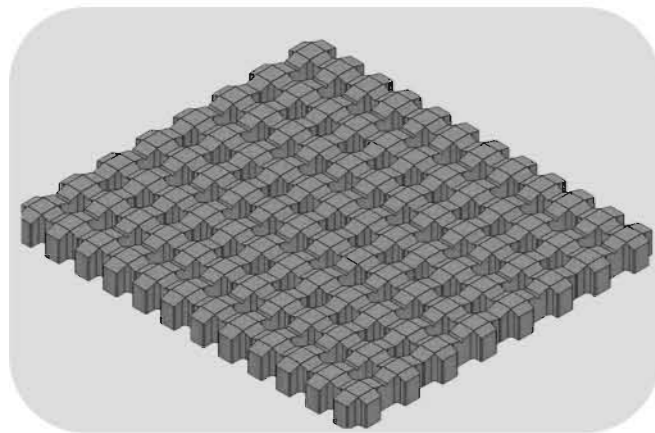
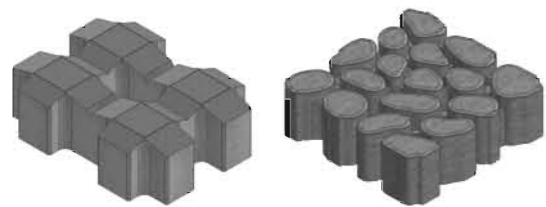

ZC4007

No.	Dimension(L x W)	Area(dm ²)	Pcs/m ²
ZC4007	198X198	4	25

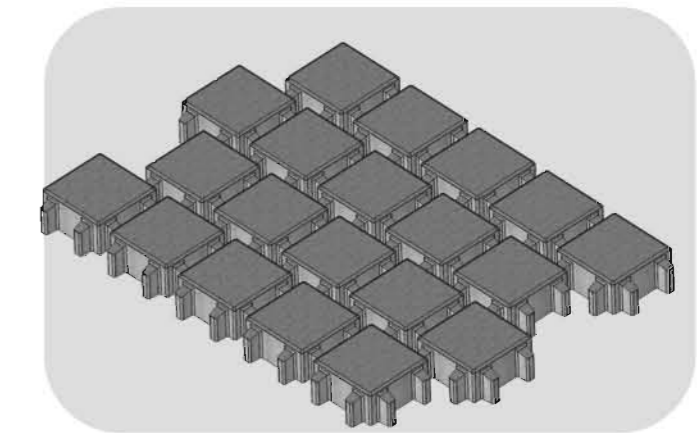
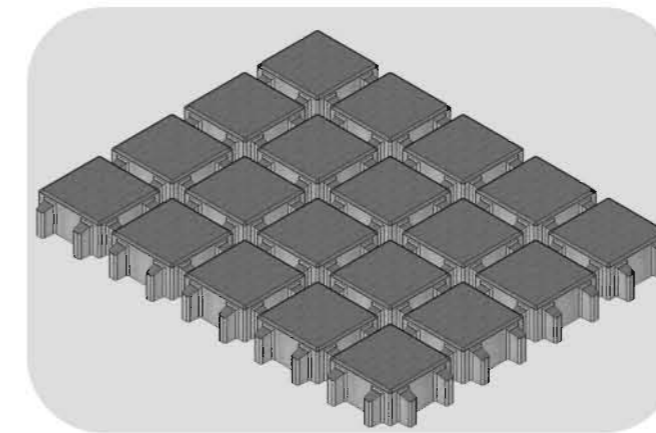
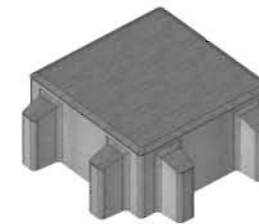

ZC4008

ZC4009

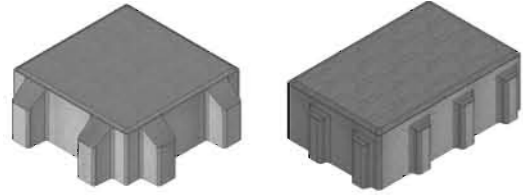

No.	Dimension(L x W)	Area(dm ²)	Pcs/m ²
ZC4008	230X230	5.29	18.9
ZC4009	240X160	3.84	26

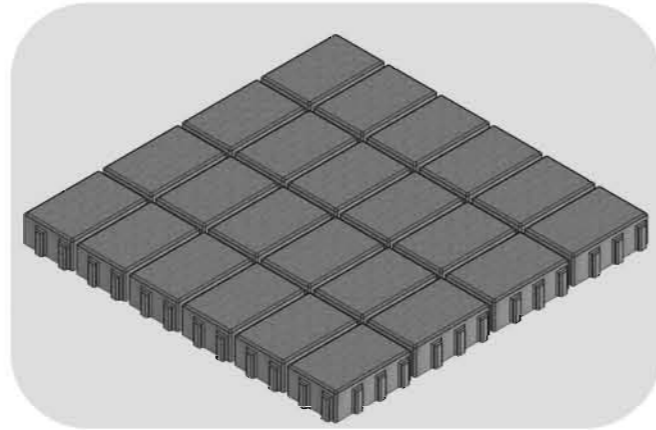
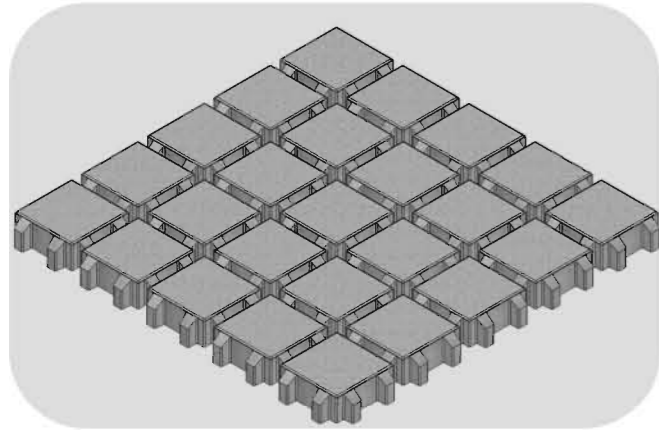

ZC4010

ZC4011

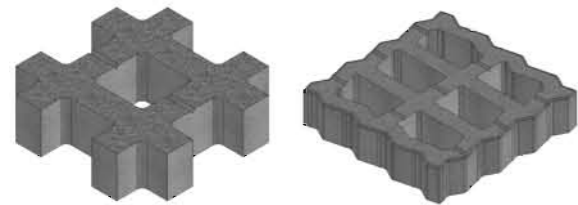

No.	Dimension(L x W)	Area(dm ²)	Pcs/m ²
ZC4010	300X300	9	11
ZC4011	453X453	20.5	4.8

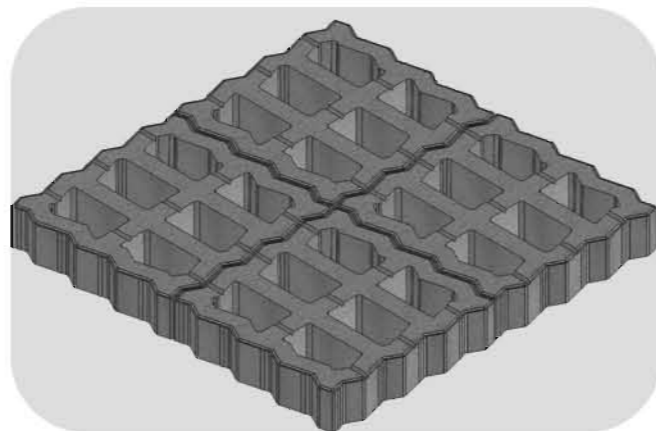
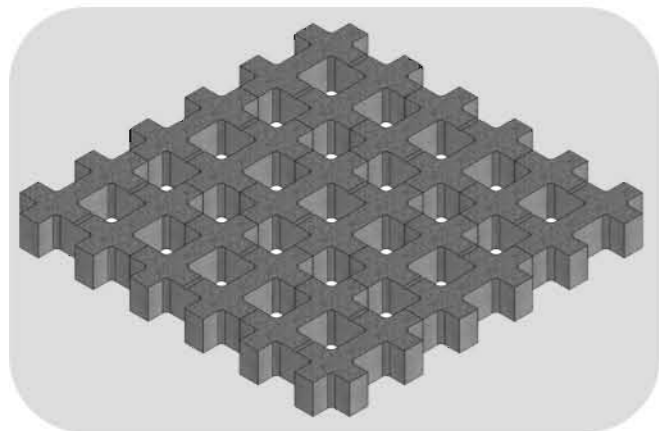

Solid Brick

No.	Dimension(L x W)
SX 2001	240X115X53
SX 2002	240X115X70
SX 2003	230X110X60
SX 2004	390X190X190
SX 2005	500X500X500

SX 2001

SX 2002

SX 2003

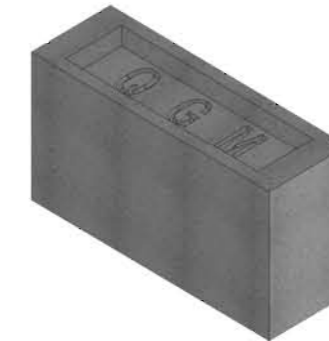

SX 2004

SX 2005

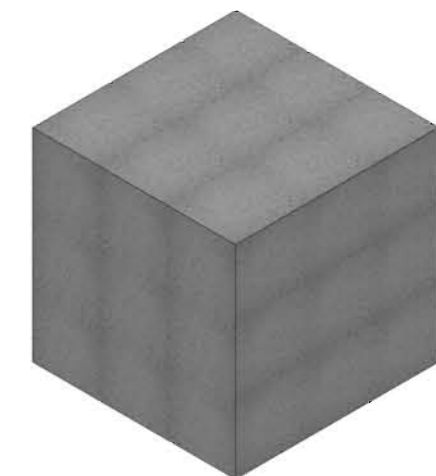
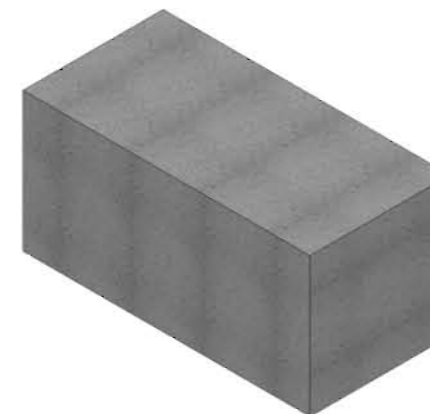



Water Conservation Brock

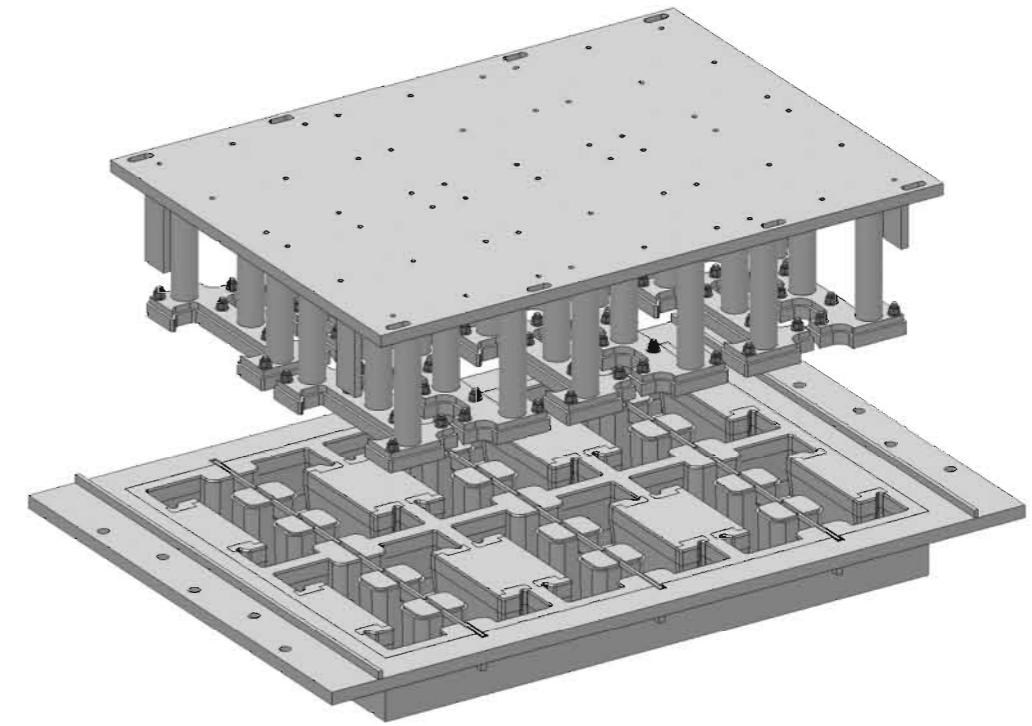

Water-conservation Brock

QGM water-conservation brock mould adopts low carbon alloy high strength carburizing steel. Moulds are smooth, strong and durable because of wiring cutting and heat treatment technology, clearance 0.5-0.8mm. Moulds pressure plates and spare parts can be easily replaced. Also, QGM can design different shapes and contours according to customers' requirements.

The specifications of water-conservation brocks have strict requirements, and the thickness, height and width of the laying need to be precisely designed. With decades of experience, QGM can provide customers with the most suitable water-conservation brock moulds, which can adapt to various water flow conditions by different sizes and shapes.

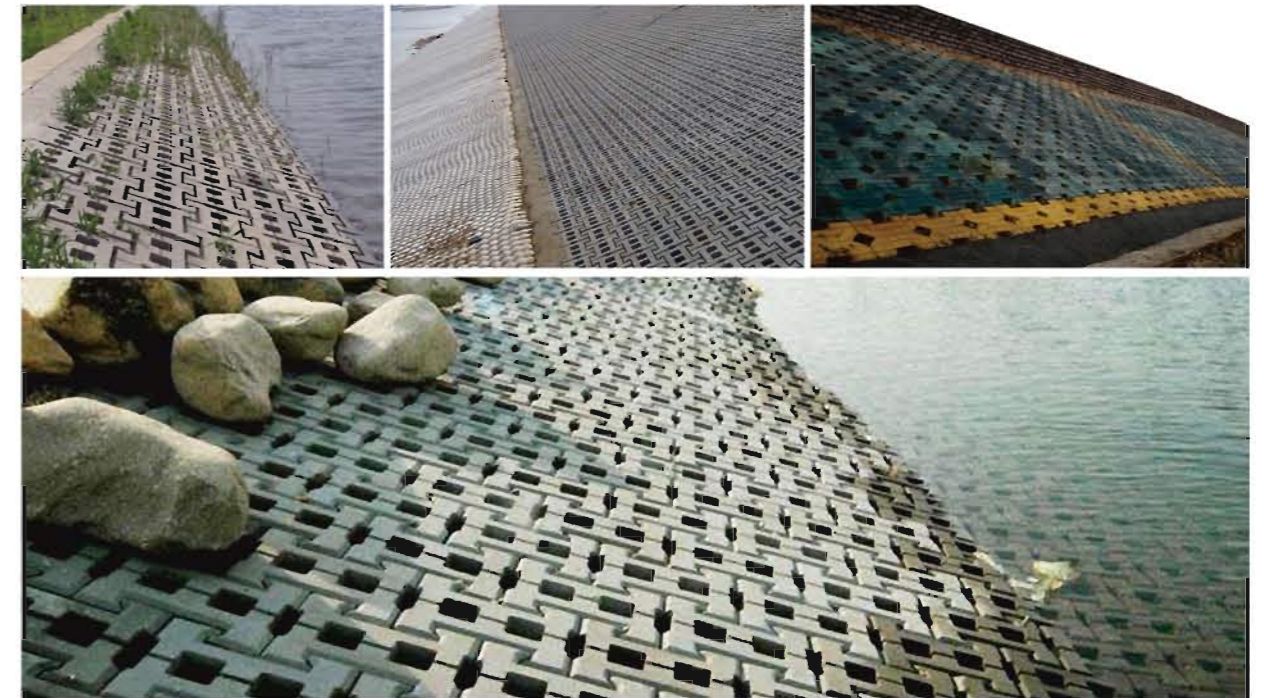

SG 5001

SG5002

No.	Dimension(L x W)
SG5001	400X300
SG5002	432X287

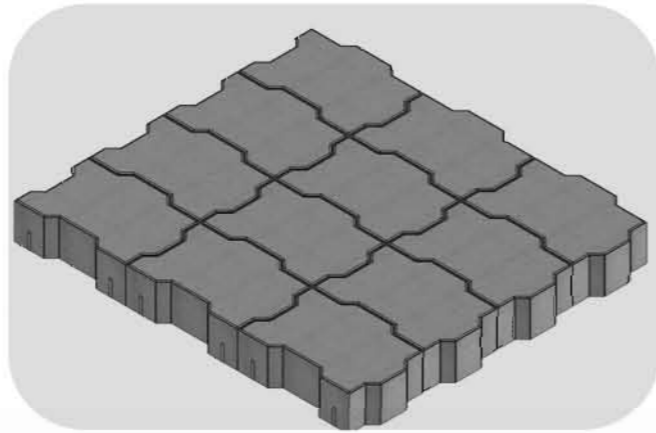
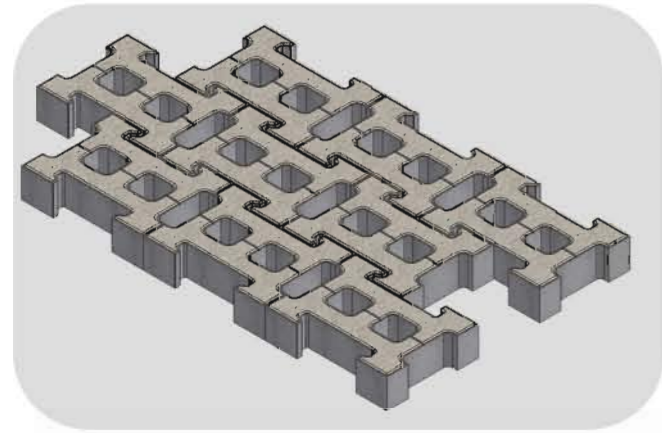
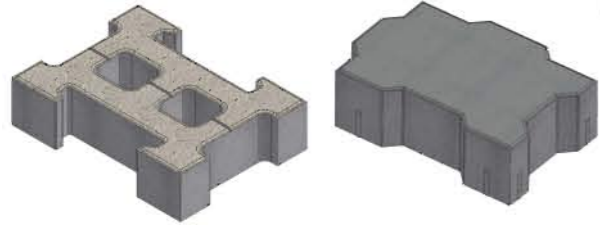

SG5005

SG5006

No.	Dimension(L x W)
SG5005	500X400
SG5006	1000X600

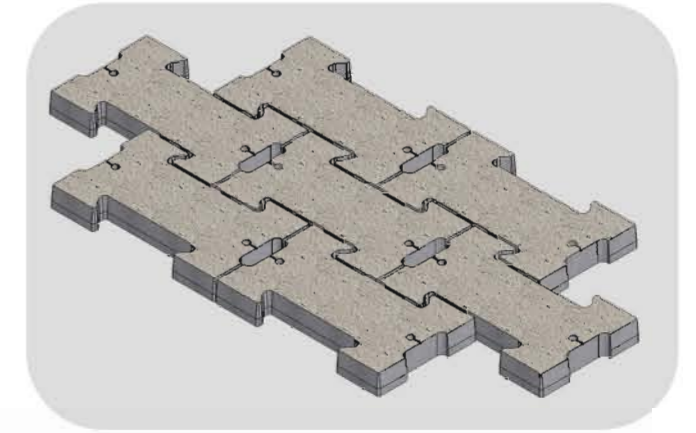
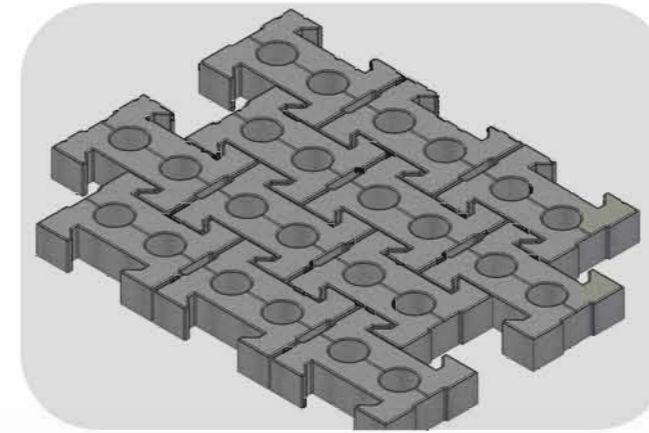

SG5003

SG5004

No.	Dimension(L x W)
SG5003	500X300
SG5004	500X400

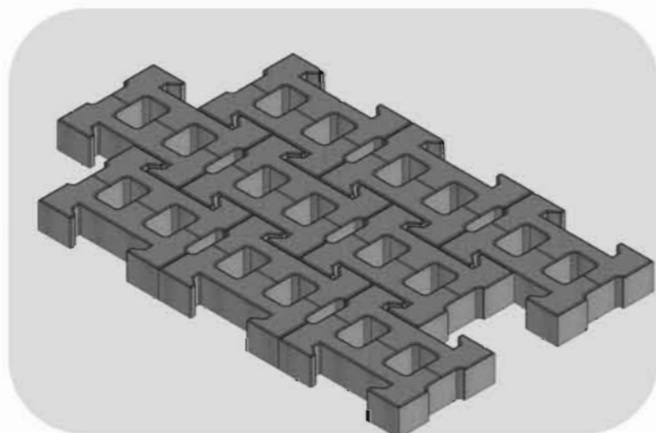
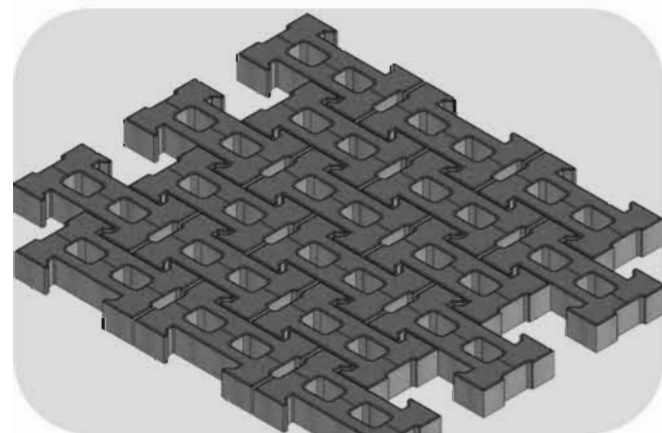
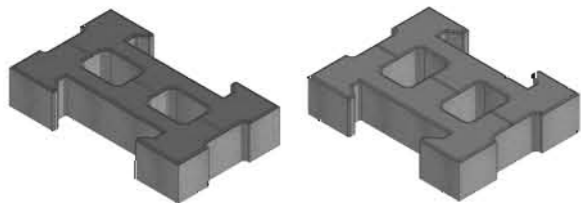



Retaining Wall Block

Retaining Wall Block

QGM retaining wall block mould adopts low carbon alloy high strength carburizing steel, hardness reaches 60-63HRC, combined with advanced welding and processing technology, clearance 0.8-1mm, which make the mould strong and durable. Meanwhile, mould plates and spare parts can be easily replaced.

Compared with other block moulds, the design of retaining wall blocks has more complicated requirements. With decades of experience, QGM can provide integrated solutions to help customers achieve the unity of appearance and function.

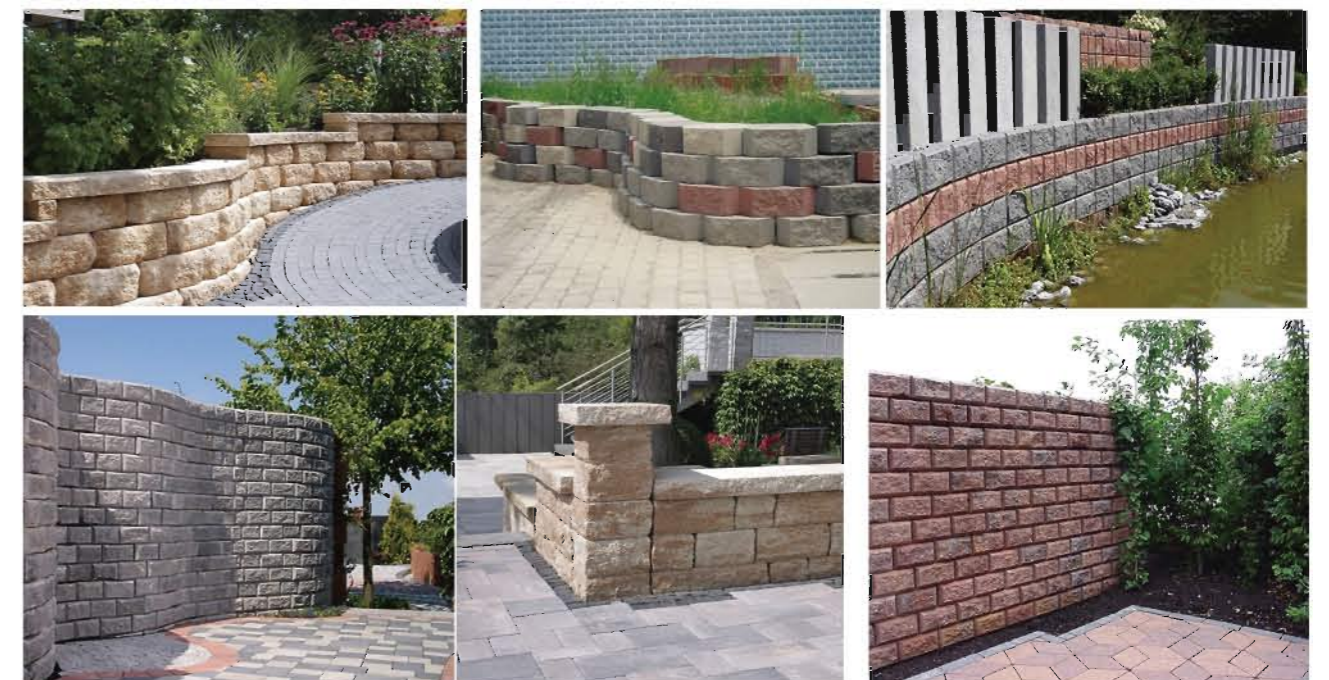

DT6001

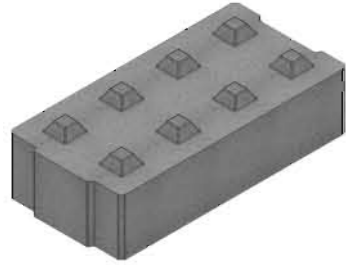

No.	Dimension(L x W)
DT6001	1000X500X250
DT6002	431X431X100
DT6003	1368X852X300
DT6004	325X280X400
DT6005	680X600X200
DT6006	498X430X250
DT6007	300X100X120
DT6008	400X300X150
DT6009	400X400X100
DT6010	500X500X250

DT6002

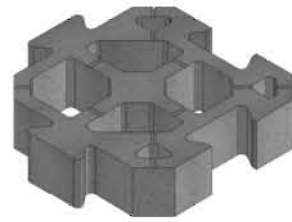

DT6003

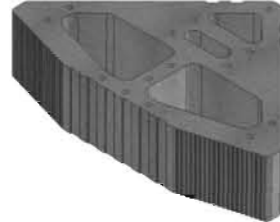

DT6004



DT6005



DT6006

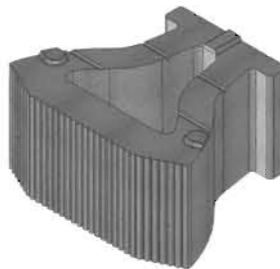

DT6007



DT6008



DT6009



DT6010



DT6002

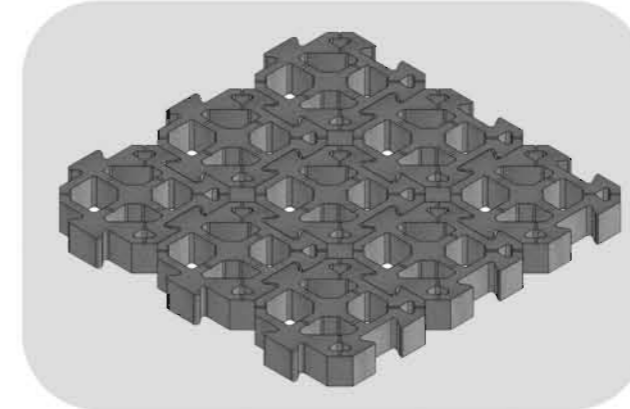

DT6004

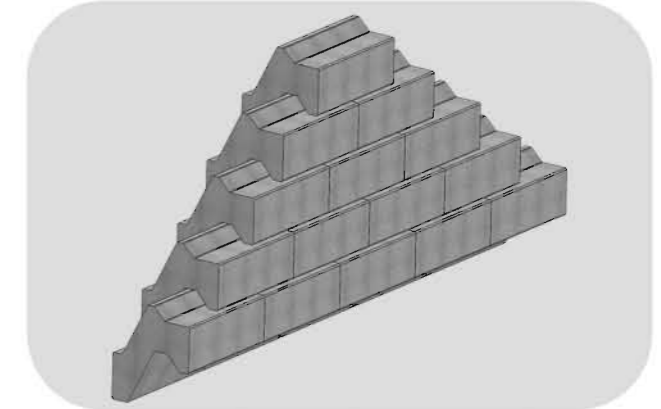

DT6004

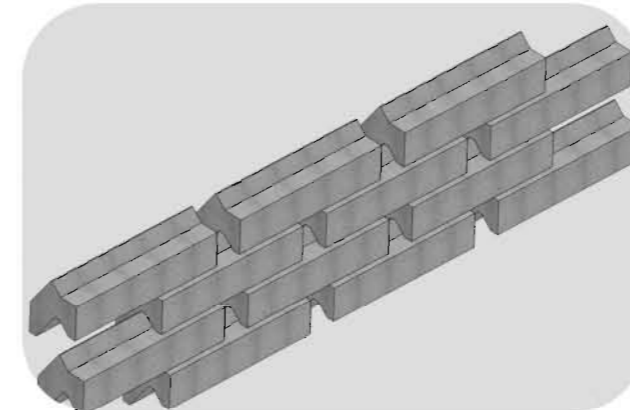

DT6010

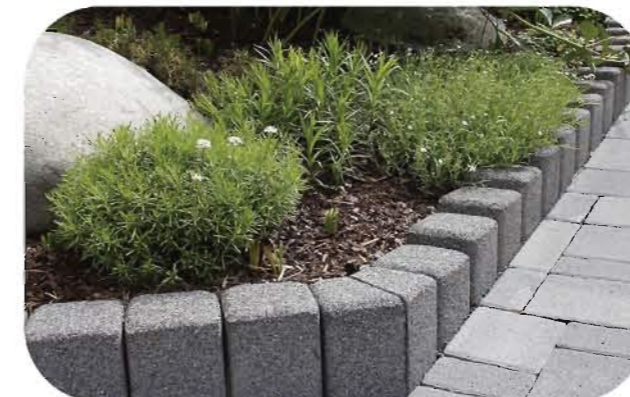
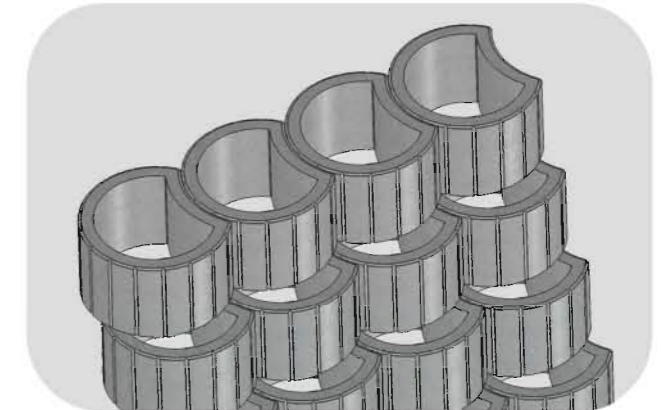

YX7001



YX7001-1

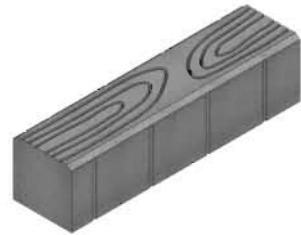

No.	Dimension(L x W)
YX7001	305X305
YX7001-1	605X305

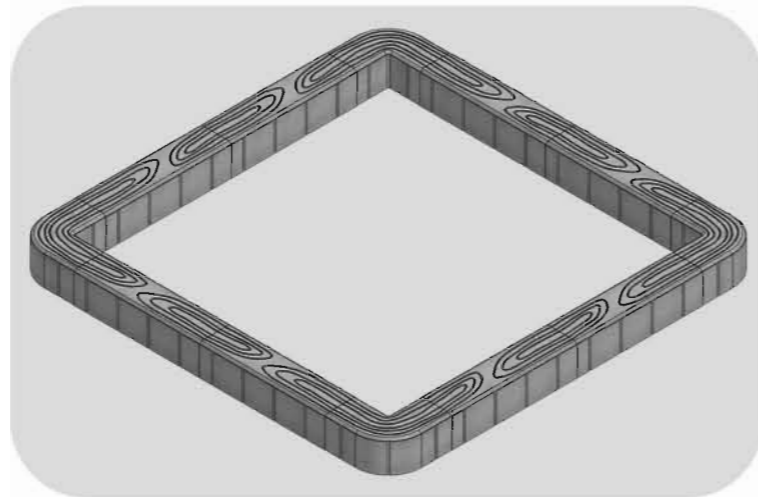

YX7003

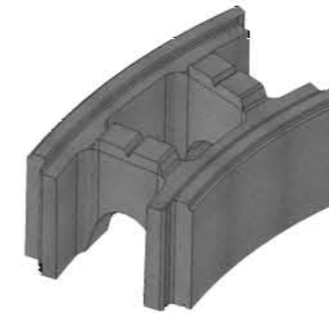

No.	Dimension(L x W)
YX7003	419X240X170

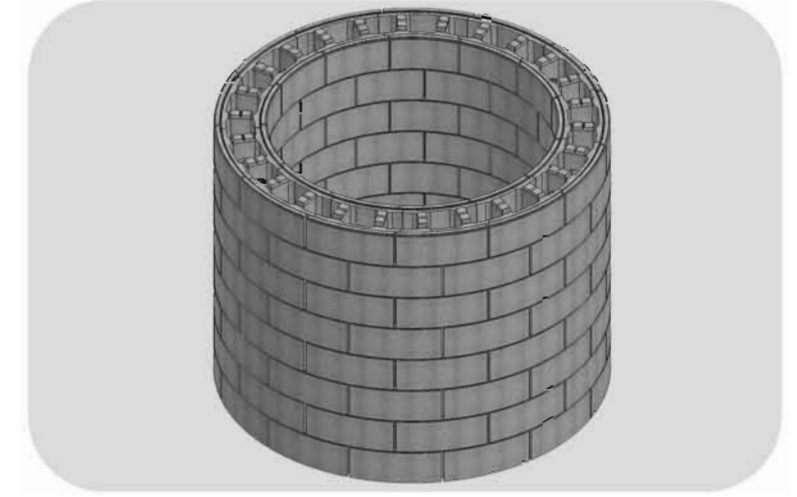

YX7002



YX7002-1



YX7002-2



No.	Dimension(L x W)
YX7002	990X990
YX7002-1	
YX7002-2	

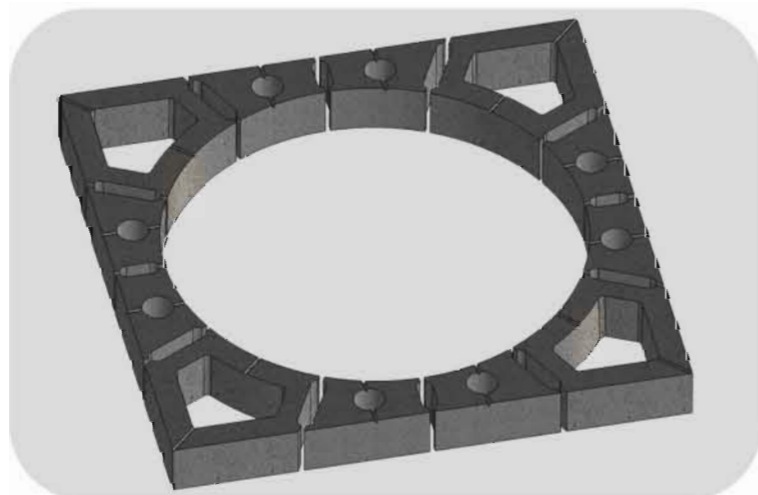

YX7004



YX7004-1



YX7004-2



YX7004-3



No.	Dimension(L x W)
YX7004	409X240X190
YX7004-1	204.5X240X190
YX7004-2	409X240X190
YX7004-3	204.5X240X190

